



# EMC TEST REPORT

**FOR**

**Ultra-Compact Embedded System**

Model : PBC-1000  
Series Model: PBC-1000  
Series,PBC-1XXXXXXXXXXXXXXXXX

("X" can be 0-9, A-Z or blank for marketing purpose)

Issued to

Vecow Co., Ltd.

3F, No. 10, Jiankang Rd., Zhonghe Dist., New Taipei City 23586, Taiwan

Issued by

WH Technology Corp.

<b>Xizhi Office and Lab</b>	<b>7F., No.262, Sec. 3, Datong Rd., Xizhi Dist., New Taipei City 221, Taiwan, (R.O.C.)</b>
<b>Tel.: +886-2-7729-7707 Fax: +886-2- 8648-1311</b>	

*Note: This test refers exclusively to the test presented test model and sample. This report shall not be reproduced except in full, without the written approval of WH Technology Corp. This document may be altered or revised by WH Technology Corp. Personnel only, and shall be noted in the revision section of the document.*



**TABLE OF CONTENTS**

**REVISION HISTORY ----- 4**

**1. GENERAL INFORMATION ----- 5**

1.1 DESCRIPTION OF THE TESTED SAMPLES ----- 7

1.2 SUMMARY OF TEST RESULT ----- 8

1.3 TEST FACILITY ----- 10

1.4 TEST METHODOLOGY ----- 11

1.5 DESCRIPTION OF THE SUPPORT EQUIPMENTS ----- 12

1.6 FEATURES OF EUT: ----- 12

**2. INSTRUMENT AND CALIBRATION ----- 13**

2.1 MEASURING INSTRUMENT CALIBRATION ----- 13

2.2 TEST AND MEASUREMENT EQUIPMENT ----- 13

2.3 TEST PERFORMED ----- 15

2.4 APPENDIX ----- 15

**3. CONDUCTED EMISSION MEASUREMENT ----- 17**

3.1 TEST SET-UP ----- 17

3.2 LIMIT ----- 17

3.3 TEST PROCEDURE ----- 17

3.4 TEST SPECIFICATION ----- 18

3.5 RESULT: PASSED ----- 18

3.6 TEST DATA: ----- 18

3.7 LIMIT OF CONDUCTED COMMON MODE DISTURBANCE AT TELECOMMUNICATION PORT ----- 19

3.8 RESULT OF CONDUCTED COMMON MODE DISTURBANCE AT TELECOMMUNICATION PORT ----- 19

**4. RADIATED EMISSION MEASUREMENT ----- 20**

4.1 TEST SETUP ----- 20

4.2 LIMIT ----- 21

4.3 TEST PROCEDURE ----- 21

4.4 TEST SPECIFICATION ----- 21

4.5 RESULT: PASSED ----- 22

4.6 TEST DATA: ----- 22

**5. POWER HARMONIC MEASUREMENT ----- 23**

5.1 TEST SETUP ----- 23

5.2 LIMITS ----- 23

5.3 TEST PROCEDURE ----- 24

5.4 TEST SPECIFICATION ----- 24

5.5 RESULT: PASSED ----- 24

5.6 TEST DATA: ----- 24

**6. VOLTAGE FLUCTUATIONS ----- 25**

6.1 TEST SETUP ----- 25

6.2 LIMITS ----- 25

6.3 TEST PROCEDURE ----- 25

6.4 TEST SPECIFICATION ----- 25

6.5 RESULT: PASSED ----- 25

6.6 TEST DATA: ----- 25

**7. PERFORMANCE CRITERIA ----- 26**

**8. ELECTROSTATIC DISCHARGE IMMUNITY TEST (ESD) ----- 27**

8.1 TEST SETUP ----- 27

8.2 TEST SPECIFICATION ----- 27



---

8.3	TEST LEVEL	27
8.4	TEST PROCEDURE	27
8.5	TEST RESULT:	28
<b>9.</b>	<b>RADIATED SUSCEPTIBILITY MEASUREMENT (RS)</b>	<b>33</b>
9.1	TEST SETUP	33
9.2	TEST SPECIFICATION	33
9.3	TEST LEVEL	33
9.1	TEST PROCEDURE	33
9.2	TEST RESULT:	34
<b>10.</b>	<b>ELECTRICAL FAST TRANSIENT/BURST (EFT)</b>	<b>35</b>
10.1	TEST SETUP	35
10.2	TEST SPECIFICATION	35
10.3	TEST PROCEDURE	35
10.4	TEST LEVEL	36
10.5	TEST RESULT:	36
<b>11.</b>	<b>SURGE</b>	<b>38</b>
11.1	TEST SETUP	38
11.2	TEST SPECIFICATION	38
11.3	TEST LEVEL	38
11.4	TEST PROCEDURE	38
11.5	TEST RESULT:	39
<b>12.</b>	<b>IMMUNITY TEST TO CS CONDUCTED DISTURBANCE (CS)</b>	<b>40</b>
12.1	TEST SETUP	40
12.2	TEST SPECIFICATION	40
12.3	TEST LEVEL	40
12.4	TEST PROCEDURE	41
12.5	TEST RESULT:	41
<b>13.</b>	<b>POWER FREQUENCY MAGNETIC FIELD (PFMF)</b>	<b>43</b>
13.1	TEST SETUP	43
13.2	TEST SPECIFICATION	43
13.3	TEST LEVEL	43
13.4	TEST PROCEDURE	43
13.5	TEST RESULT	43
<b>14.</b>	<b>VOLTAGE DIPS AND INTERRUPTION MEASUREMENT(DIPS)</b>	<b>45</b>
14.1	TEST SETUP	45
14.2	TEST SPECIFICATION	45
14.3	TEST LEVEL	45
14.4	TEST PROCEDURE	46
14.5	TEST RESULT:	46
<b>15.</b>	<b>MEASUREMENT UNCERTAINTY</b>	<b>47</b>
<b>APPENDIX 1</b>		<b>48</b>
<b>APPENDIX 2</b>		<b>56</b>
<b>TEST DATA – POWER HARMONIC</b>		<b>68</b>



REVISION HISTORY

Rev.	Issue Date	Revisions	Effect Page	Revised By
00	Apr. 22, 2022	Initial Issue	ALL	Ely



**1. GENERAL INFORMATION**

**Applicant** : Vecow Co., Ltd.  
**Address** : 3F, No. 10, Jiankang Rd., Zhonghe Dist., New Taipei City 23586, Taiwan  
**Manufacturer** : Vecow Co., Ltd.  
**Address** : 3F, No. 10, Jiankang Rd., Zhonghe Dist., New Taipei City 23586, Taiwan  
**EUT** : Ultra-Compact Embedded System  
**Model Name** : PBC-1000  
**Series model Name** : PBC-1000 Series,PBC-1XXXXXXXXXXXXXXXXX  
( "X" can be 0-9, A-Z or blank for marketing purpose)  
**Receipt Date** : Mar. 29, 2022  
**Final Test Date** : Apr. 22, 2022

**Measurement procedure used:**

<b>CISPR 32: 2015+ Cor:2016</b>	<b>EN 55035:2017+A11:2020</b>
<b>AS/NZS CISPR 32:2015</b>	<b>EN 61000-4-2:2009</b>
<b>EN 55032:2015+A11:2020</b>	<b>EN IEC 61000-4-3:2020</b>
<b>EN 61000-3-2 : 2014</b>	<b>EN 61000-4-4:2012</b>
<b>EN 61000-3-3 : 2013</b>	<b>EN 61000-4-5:2014/A1:2017</b>
	<b>EN 61000-4-6:2014/AC:2015</b>
	<b>EN 61000-4-8:2010</b>
	<b>EN IEC 61000-4-11:2020</b>

**UKCA EMI:**

**BS EN 55032:2015+A11:2020**  
**BS EN 61000-3-2 : 2014**  
**BS EN 61000-3-3 : 2013**

**UKCA EMS:**

**BS EN 55035:2017+A11:2020**  
**BS EN 61000-4-2: 2009**  
**BS EN 61000-4-3:2020**  
**BS EN 61000-4-4 : 2012**  
**BS EN 61000-4-5:2014+A1:2017**  
**BS EN 61000-4-6:2014/AC:2015**  
**BS EN 61000-4-8: 2010**  
**BS EN 61000-4-11: 2020**



### **Deviation from Applicable Standard**

The above equipment was tested by WH Technology Corp. for compliance with EMC requirements set forth in the EUROPEAN COUNCIL DIRECTIVE 2014/30/EU and Electromagnetic Compatibility Regulations 2016 and the technical standards mentioned above. The results of testing in this report apply only to the product/system, which was tested. Other similar equipment will not necessarily produce the same results due to production tolerance.

This test report shall not be reproducing in part without written approval of WH Technology Corp.

**Tested By:**

**Reviewed by:**

Apr. 22, 2022

**Date**

\_\_\_\_\_  
Bing Chang/ Project Engineer

Apr. 22, 2022

**Date**

\_\_\_\_\_  
Bell Wei / Manager  
TAF Accreditation Number: 2954



---

### 1.1 DESCRIPTION OF THE TESTED SAMPLES

EUT Name : Ultra-Compact Embedded System

Model Number : PBC-1000

Receipt Date : 03/29/2022

EUT Power Rating :  AC 110V/60Hz  
 DC 12V  
 DC 5V from PC  
 from Adaptor

EUT highest operating frequency : 100 MHz

EUT Covered : Adaptor  
Model:HA-1600-12  
Input:100-240Vac, 1.7A, 50-60Hz  
Output:12Vdc, 5.0A, 60W

I/O Port of EUT : COM port x2  
SIM port x1  
RJ45 x2  
DP x1  
USB port x2

Interface : Display Port: Up to 4096 x 2160 @60Hz



## 1.2 SUMMARY OF TEST RESULT

Test Result measurement is not including uncertainty.

Emission				
Test Standard	Test Item	Limit	Test Result	Remark
EN 55032:2015+A11:202 0	Conducted emission	Class A	PASS	
	Conducted emission at telecommunication ports	Class A	PASS	NOTE (1)
	Radiated emission Below 1 GHz	Class A	PASS	
	Radiated emission Above 1 GHz	Class A	N/A	NOTE (2)
EN 61000-3-2: 2014	Harmonic current emissions	Class A	PASS	NOTE (3)
EN 61000-3-3: 2013	Voltage fluctuations	-----	PASS	

Immunity EN 55035:2017+A11:2020				
Test Standard	Test Item	Performance Criterion	Test Result	Remark
EN 61000-4-2:2009	Electrostatic discharge	B	Pass	
EN IEC 61000-4-3:2020	Radiated Frequency electromagnetic field	A	Pass	
EN 61000-4-4:2012	Electrical fast transient/burst	B	Pass	
EN 61000-4-5:2014/A1:2017	Surge	B / C	Pass	NOTE (4)
EN 61000-4-6:2014/AC:2015	Conducted Disturbances induced by Radio-Frequency Fields	A	Pass	
EN 61000-4-8:2010	Power Frequency Magnetic Field	A	Pass	
EN IEC 61000-4-11:2020	Voltage Dips and Interruption	B / C / C NOTE (5)	Pass	

**NOTE:**

- 1) "N/A" denotes test is not applicable in this Test Report.
- 2) If the EUT's highest operating frequency does not exceed 108 MHz, the test will not be performed.
- 3) if the EUT's category is Class D and power consumption is less than 75W, there is no limit applied.
- 4) Performance Criterion B for input a.c. and d.c. power ports.  
Performance Criterion C for signal ports and telecommunication ports.
- 5) Voltage Dips: >95% - Performance Criterion B  
Voltage Dips: 30% - Performance Criterion C  
Voltage Interruption: >95% - Performance Criterion C







### 1.3 TEST FACILITY

The test facilities used to collect the test data in this report:

**Conducted emission Test:**

**C01:** 7F., No.262, Sec. 3, Datong Rd., Xizhi Dist., New Taipei City 221, Taiwan, (R.O.C.)

**C02:** No. 67-22, Baoxin St., Xizhi Dist., New Taipei City 221, Taiwan (R.O.C.)

**Conducted emission at telecommunication ports Test:**

**C01:** 7F., No.262, Sec. 3, Datong Rd., Xizhi Dist., New Taipei City 221, Taiwan, (R.O.C.)

**C02:** No. 67-22, Baoxin St., Xizhi Dist., New Taipei City 221, Taiwan (R.O.C.)

**Radiated emission Test (Below 1 GHz):**

**OS01:** No.120, Ln. 5, Hudong St., Xizhi Dist., New Taipei City 221, Taiwan (R.O.C.)

**CB02:** No. 67-22, Baoxin St., Xizhi Dist., New Taipei City 221, Taiwan (R.O.C.)

**Radiated emission Test (Above 1 GHz):**

**OS01:** No.120, Ln. 5, Hudong St., Xizhi Dist., New Taipei City 221, Taiwan (R.O.C.)

**CB02:** No. 67-22, Baoxin St., Xizhi Dist., New Taipei City 221, Taiwan (R.O.C.)

**The immunity test:**

No. 67-22, Baoxin St., Xizhi Dist., New Taipei City 221, Taiwan (R.O.C.)



## 1.4 TEST METHODOLOGY

### EUT SYSTEM OPERATION

1. All peripherals connect EUT and power on.

### DESCRIPITON OF TEST MODES

To investigate the maximum EMI emission characteristics generates from EUT, the test system was pre-scanning tested base on the consideration of following EUT operation mode or test configuration mode which possible have effect on EMI emission level. Each of these EUT operation mode(s) or test configuration mode(s) mentioned above was evaluated respectively.

Pretest Test Mode	Description
Mode 1(worst)	All System(230Vac)
Mode 2	All System(110Vac)

Conducted emission test	
Final Test Mode	Description
Mode 1(worst)	All System(230Vac)

Conducted emission at telecommunication ports test	
Final Test Mode	Description
Mode 3	LAN1 10Mbps
Mode 4	LAN1 100Mbps
Mode 5	LAN1 1Gbps
Mode 6	LAN2 10Mbps
Mode 7	LAN2 100Mbps
Mode 8(worst)	LAN2 1Gbps

Radiated emission test	
Final Test Mode	Description
Mode 1(worst)	All System(230Vac)

Harmonic current emissions & Voltage fluctuations	
Final Test Mode	Description
Mode 1(worst)	All System(230Vac)

Immunity tests	
Final Test Mode	Description
Mode 1(worst)	All System(230Vac)

Note: Display 3840x2160



## 1.5 DESCRIPTION OF THE SUPPORT EQUIPMENTS

### Setup Diagram

See test photographs attached in APPENDIX 1 for the actual connections between EUT and support equipment.

### Support Equipment

OUTSIDE SUPPORT EQUIPMENT							
No.	Equipment	Model	Serial No.	FCC ID	Trade name	Data Cable	Power Cord
1.	RS232 terminal	N/A	N/A	N/A	N/A	N/A	N/A
2.	RS232 terminal	N/A	N/A	N/A	N/A	N/A	N/A
3.	Server PC	D19M	CYY7Y A00 DC4	R33002	DELL	N/A	Unshielded 1.8m
4.	Monitor	BL2420-T	EJ35J00797019	R33037	BENQ	Shielded 1.8m	Unshielded 1.8m
5.	Mouse	MS116p	CN-04DWDN-73826-5CM-0120	R41108	DELL	Shielded 1.8m / USB	N/A
	Keyboard	KB216p	CN-005TW2-71581-5 AF-01I3-A01	D41108	DELL	Shielded 1.8m / USB	N/A

#### **Note:**

- (1) The support equipment was authorized by Declaration of conformity (DOC).
- (2) All the above equipment/cable were placed in worse case position to maximize emission signals during emission test.
- (3) Grounding was established in accordance with the manufacturer's requirement and conditions for the intended use.

## 1.6 FEATURES OF EUT:

Please refer to user manual or product specification.



## 2. INSTRUMENT AND CALIBRATION

### 2.1 MEASURING INSTRUMENT CALIBRATION

The measuring equipment utilized to perform the tests documented in the report has been calibrated once a year or in accordance with the manufacturer’s recommendations, and is traceable to recognized national standards.

### 2.2 TEST AND MEASUREMENT EQUIPMENT

The following list contains measurement equipment used for testing. The equipment conforms to the requirement of CISPR 16-1, ANSI C63.2 and. Other required standards. Calibration of all test and measurement, including any accessories that may effect such calibration, is checked frequently to ensure the accuracy. Adjustments are made and correction factors are applied in accordance with the instructions contained in the respective.

**TABLELIST OF TEST AND MEASUREMENT EQUIPMENT**

Conducted emission				
Instrument	Manufacturer	Model No.	Serial No.	Cali Due Date
EMI Test Receiver	R&S	ESHS30	838550/003	2022/09/29
Spectrum Analyzer	R&S	FSP7	830180/009	2022/09/29
LISN	Schwarzbeck	NNLK 8121	8121#734	2022/09/09
ISN	Schwarzbeck	NTFM 8158	8158#125	2022/10/02
Test Cable	NA	RG316	WH-CON06	2022/10/12
Measurement Software	AUDIX	e3	V9.160707	N/A
Radiated emission Below 1GHz				
Instrument	Manufacturer	Model No.	Serial No.	Cali Due Date
Bilog antenna	ETC	MCTD2786B	BLB19O04027/J B-5-027	2022/11/10
LOOP Antenna	EMCO	6507	9301-1298	2023/02/16
Pre-amplifier	EMCI	EMC9135	980334	2022/07/15
Cable	EMCI	N male on end of both sides (EMI4)	30m	2023/03/20
Receiver	R&S	ESVS30	826006/002	2023/02/15
Spectrum Analyzer	R&S	FSP7	830180/006	2022/05/11
Measurement Software	AUDIX	e3	V6.101222a	N/A
Radiated emission Above 1GHz				
Instrument	Manufacturer	Model No.	Serial No.	Cali Due Date



Horn antenna	ETS LINDGREN	3117	00114397	2022/07/28
Pre-amplifier	EMCI	EMC051845	980108	2023/03/30
RF CABLE	SUCOFLEX	104PEA	27348/4PEA	2022/09/06
RF CABLE	AGILENT	EMC102-KM-K M-3000	160101	2022/09/14
Spectrum Analyzer	ADVANTEST	R3182	150900201	2023/04/13
Notch Filter	EMC INSTRUMENT	EWT-14-0166	G1	2022/05/12
Measurement Software	AUDIX	e3	V6.101222a	N/A
<b>Harmonic/Flicker</b>				
<b>Instrument</b>	<b>Manufacturer</b>	<b>Model No.</b>	<b>Serial No.</b>	<b>Cali Due Date</b>
AC Power Source	California Instruments	5001iX-400-413 -411-MODE-CT S	HK 54194	2023/01/12
Test Analyzer	TESEQ	CCN 1000-1	1249A02222	2023/01/12
Measurement Software	AMETEK	CTS 4	V4.24.0	NA
<b>Immunity</b>				
<b>Instrument</b>	<b>Manufacturer</b>	<b>Model No.</b>	<b>Serial No.</b>	<b>Cali Due Date</b>
ESD Simulator	Noiseken	ESS-2002	ESS0767151	2023/02/09
SIGNAL GENERATOR	Agilent	N5182A	MY50144390	2023/02/14
Log Periodic Antenna	SCHWARZBECK	STLP 9129	9129 101	N/A
Electric Field Probe	PMM	EP 601	611WX70786	2022/04/26
Power Meter	Agilent	E4419B	MY41291664	2023/02/15
Power Sensor	Agilent	8481D	MY41091347	2023/02/16
Power Sensor	Agilent	E9301	US39211864	2023/02/16
Amplifier	TESEQ	CBA 1G-300B	W2408-1218	N/A
Amplifier	MILMEGA	AS0860B-50-50	1085442	N/A
Measurement Software	AR	emcware	V3.6.0	N/A
EMC Immunity Test System	EMC PARTNER	TRANSIENT 2000IN6	456	2022/05/30
Capacitive Clamp	EMC PARTNER	CN-EFT1000	268	2022/05/30
Telccom Surge Module	SKYLARK	LSG-6K20	0506C1817	2022/07/07
Conducted Immunity Test System	FRANKONIA	CIT-10-75-MIL	18901628-0101	2023/03/11



CDN	FRANKONIA	CDN M2+M3	A3011021	2023/03/15
CDN	FRANKONIA	CDN RJ45	A3023011	2023/03/15
EM clamp	FCC	F-203I-23MM	520	2023/03/15
Measurement Software	Frankonia	CD-LAB C5.315	V1435V2372015	N/A
Magnetic Field Immunity Loop	EMC PARTNER	MF-1000-1-69	169	2022/05/30
EMF Tester	TES	1390	110305943	2023/03/10

Remark: "N/A" denotes No Model Name, No Serial No. or No Calibration specified.

## 2.3 TEST PERFORMED

Conducted emissions were investigated over the frequency range from 0.15 MHz to 30 MHz using a receiver which resolution bandwidth is set at 9 kHz.

Radiated emissions were investigated over the frequency range from 30 MHz to 1000 MHz using a receiver which resolution bandwidth is set at 120 kHz. Radiated measurement was performed at distance that from an antenna to EUT is 10 meters.

## 2.4 APPENDIX

### Appendix A: Measurement Procedure for Main Power Port Conducted Emissions

The measurements are performed in a WH lab test room; The EUT was placed on non-conductive 1.0m x 1.5m table, which is 0.8 meters above an earth-grounded.

Power to the EUT was provided through the LISN which has the Impedance (50 ohm/50 uH) vs. Frequency Characteristic in accordance with the standard. Powers to the LISNs were filtered to eliminate ambient signal interference and these filters were bonded to the ground plane. Peripheral equipment required to provide a functional system (support equipment) for EUT testing was powered from the second LISN through a ganged, metal power outlet box which is bonded to the ground plane at the LISN.

If the EUT is supplied with a flexible power cord, the power cord length in excess of the distance separating the EUT from the LISN shall be folded back and forth at the center of the lead so as to form a bundle not exceeding 40cm in length. If the EUT is provided with a permanently coiled power cord, bundling of the cord is not required. If the EUT is supplied without a power cord, the EUT shall be connected to the LISN by a power cord of the type specified by the manufacturer which shall not be longer than 1 meter. The excess power cord shall be bundled as described above. If a non-flexible power cord is provided with the EUT, it shall be cut to the length necessary to attach the EUT to the LISN and shall not be bundled.

The interconnecting cables were arranged and moved to get the maximum measurement. Both the line of power cord, hot and neutral, was measured.



The highest emissions were analyzed in details by operating the spectrum analyzer in fixed tuned mode to determine the nature of the emissions and to provide information which could be useful in reducing their amplitude.

## **Appendix B: Test Procedure for Radiated Emissions**

### **Preliminary Measurements in 743 Semi Anechoic Chamber**

The radiated emissions are initially measured in the anechoic chamber at a measurement distance of 3 meters. Desktop EUT are placed on a wooden stand 0.8 meter in height. The measurement antenna is 3 meters from the EUT. The test setup in anechoic chamber is the same as open site. The turntable rotated 360°C. The antenna height is 1m. The primary objective of the radiated measurements in the anechoic chamber is to identify the frequency spectrum in the absence of the electromagnetic environment existing on the open test site. The frequencies can then be pre-selected on the open test site to obtain the corresponding amplitude. The initial scan is made with the spectrum analyzer in automatic sweep mode. The spectrum peaks are then measured manually to determine the exact frequencies.

### **Measurements on the Open Site or 1166 Semi Anechoic Chamber**

The radiated emissions test will then be repeated on the open site or chamber to measure the amplitudes accurately and without the multiple reflections existing in the shielded room. The EUT and support equipments are set up on the turntable. Desktop EUT are set up on a wooden stand 0.8 meter above the ground.

For the initial measurements, the receiving antenna is varied from 1-4-meter height and is changed in the vertical plane from vertical to horizontal polarization at each frequency. Both reading is recorded with the quasi-peak detector with 120 kHz bandwidth. For frequency between 30 MHz and 1000 MHz, the reading is recorded with peak detector or quasi-peak detector.

At the highest amplitudes observed, the EUT is rotated in the horizontal plane while changing the antenna polarization in the vertical plane to maximize the reading. The interconnecting cables were arranged and moved to get the maximum measurement. Once the maximum reading is obtained, the antenna elevation and polarization will be varied between specified limits to maximize the readings.





### 3. CONDUCTED EMISSION MEASUREMENT

#### 3.1 TEST SET-UP

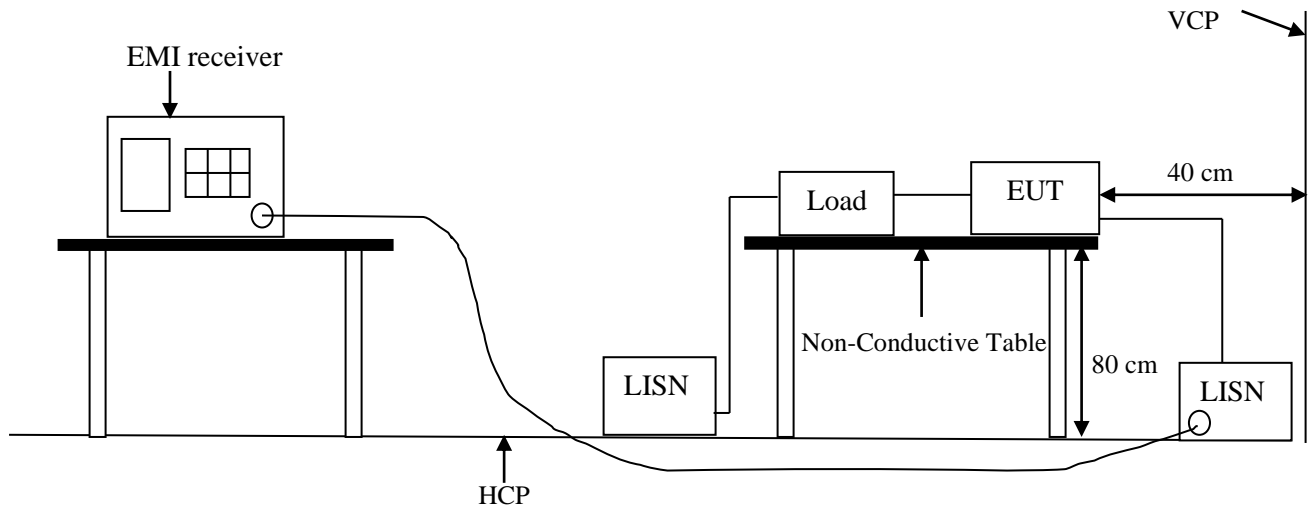

#### 3.2 LIMIT

Frequency range (MHz)	CLASS A		CLASS B	
	QP (dBμV)	Average (dBμV)	QP (dBμV)	Average (dBμV)
0.15 – 0.5	79	66	66 - 56	56 - 46
0.5 – 5.0	73	60	56	46
5.0 – 30	73	60	60	50

NOTE:

- 1) In the above table, the tighter limit applies at the band edges.
- 2) The test result calculated as following:  
 Level Value = Reading Level + Factor  
 Factor = Insertion Loss + Cable Loss + Attenuator Factor (if use)  
 Over Limit Value = Level Value – Limit Value

#### 3.3 TEST PROCEDURE

Please refer to

Appendix A: Measurement Procedure for Main Power Port Conducted Emissions

Note:

1. Reading in which marked as Peak, QP or AVG means measurements by using are Quasi-Peak or Average Mode with Detector BW=9 kHz (6 dB Bandwidth).
2. All readings are Peak Mode value unless otherwise stated QP or AVG in column of Note. If the Peak or QP Mode Measured value compliance with the QP



Limits and lower than AVG Limits, the EUT shall be deemed to meet both QP & AVG Limits and then only Peak or QP Mode was measured, but AVG Mode didn't perform.

**3.4 TEST SPECIFICATION**

According to EN 55032 Class A

(Please refer to Page 5 for dated references which are related to the standard as mentioned above)

**3.5 RESULT: PASSED**

Model Name	PBC-1000
Test Voltage	AC 230V/50Hz
Temperature:	20 °C
Humidity:	50 % RH

**3.6 TEST DATA:**

Please refer to APPENDIX 2



**3.7 LIMIT OF CONDUCTED COMMON MODE DISTURBANCE AT TELECOMMUNICATION PORT**

**TEST STANDARD: EN 55032**

Frequency Range	Class A (dB $\mu$ V)		Class B (dB $\mu$ V)	
	Quasi Peak	Average	Quasi Peak	Average
0.15 – 0.5 MHz	97 – 87	84 – 74	84 – 74	74 – 64
0.5 – 30 MHz	87	74	74	64

**NOTE:**

- 1) The limits decrease linearly with the logarithm of the frequency in the range 0.15 MHz to 0.5MHz.
- 2) The test result calculated as following:  
Level Value = Reading Level + Factor  
Factor = Insertion Loss + Cable Loss + Attenuator Factor (if use)  
Over Limit Value = Level Value – Limit Value

**3.8 RESULT OF CONDUCTED COMMON MODE DISTURBANCE AT TELECOMMUNICATION PORT**

TEST RESULT: **PASSED.**

**Note:**

1. Reading in which marked as Peak, QP or AVG means measurements by using are Quasi-Peak or Average Mode with Detector BW=9 kHz (6 dB Bandwidth).
2. All readings are Peak Mode value unless otherwise stated QP or AVG in column of Note. If the Peak or QP Mode Measured value compliance with the QP Limits and lower than AVG Limits, the EUT shall be deemed to meet both QP & AVG Limits and then only Peak or QP Mode was measured, but AVG Mode didn't perform.



## 4. RADIATED EMISSION MEASUREMENT

### 4.1 TEST SETUP

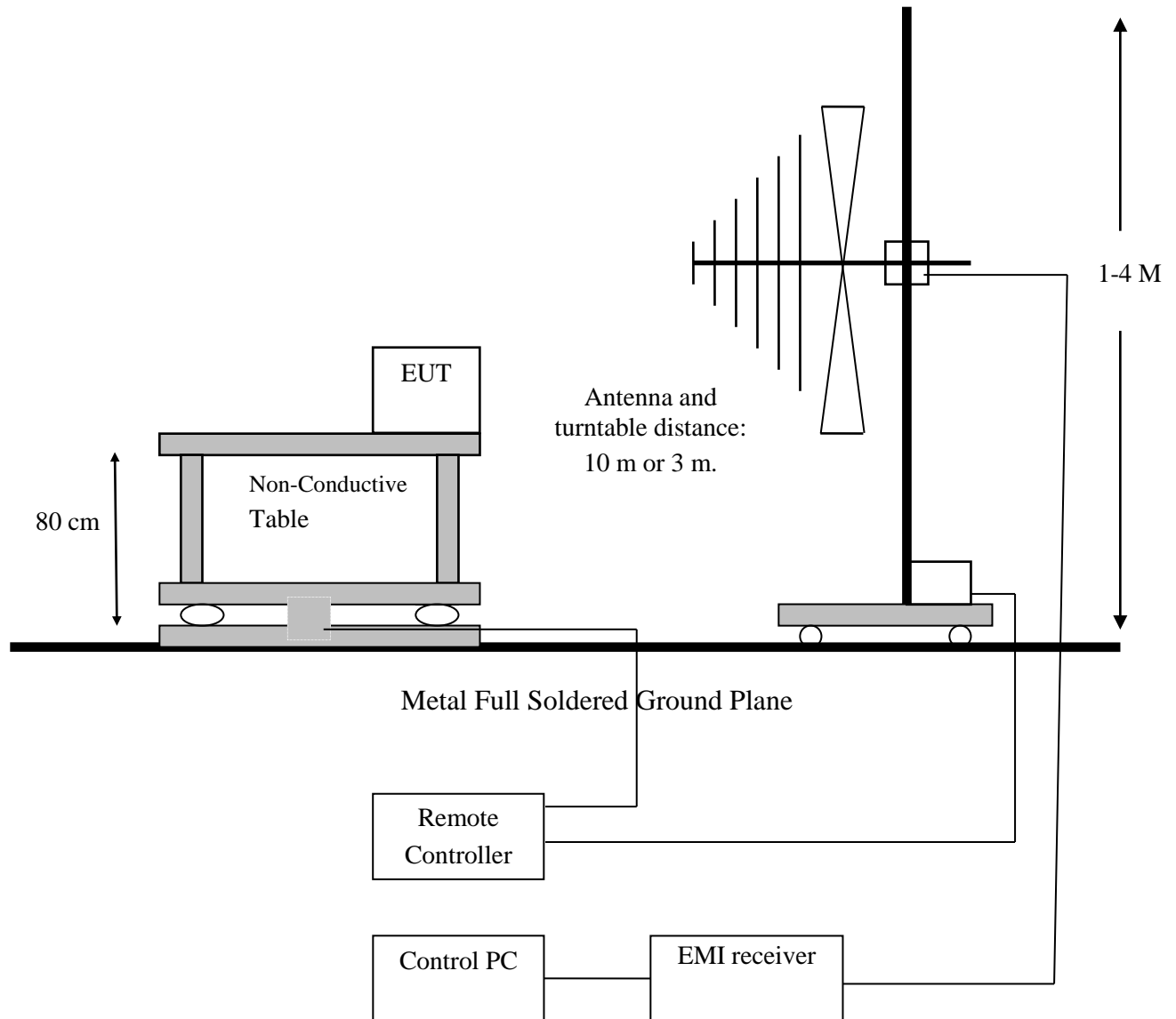



## 4.2 LIMIT

Frequency	Class A		Class B	
MHz	Quasi-peak at 3m (dB $\mu$ V/m)	Quasi-peak at 10m (dB $\mu$ V/m)	Quasi-peak at 3m (dB $\mu$ V/m)	Quasi-peak at 10m (dB $\mu$ V/m)
30 ~ 230	50	40	40	30
230 ~ 1000	57	47	47	37

Frequency range (GHz)	Class A (at 3m)		Class B (at 3m)	
	Average (dB $\mu$ V/m)	Peak (dB $\mu$ V/m)	Average (dB $\mu$ V/m)	Peak (dB $\mu$ V/m)
1 ~ 3	56	76	50	70
3 ~ 6	60	80	54	74

### NOTE:

- 1) In the above table, the tighter limit applies at the band edges.
- 2) The test result calculated as following:  
Level Value = Reading Level + Factor  
Factor = Antenna Factor + Cable Loss – Amplifier Gain (if use)  
Over Limit Value = Level Value – Limit Value

## 4.3 TEST PROCEDURE

Please refer to

Appendix B: Test Procedure for Radiated Emissions

### Note:

(Below 1 GHz)

1. Reading in which marked as QP or Peak means measurements by using are Quasi-Peak Mode with Detector BW=120 kHz.

2. All readings are Peak unless otherwise stated QP in column of Note. Peak denotes that the Peak reading compliance with the QP Limits and then QP Mode measurement didn't perform.

(Above 1 GHz)

1. Reading in which marked as Peak means measurements by using are Peak Mode with instrument setting in RBW=1 MHz, VBW= 1MHz.

Reading in which marked as AV means measurements by using are Average Mode with instruments setting in RBW=1 MHz, VBW= 10Hz.

2. All readings are Peak Mode value unless otherwise stated AVG in column of Note. If the Peak be deemed to meet both Peak & AVG Limits and then only Peak Mode was measured, but AVG Mode didn't perform.

## 4.4 TEST SPECIFICATION

According to EN 55032 Class A



(Please refer to Page 5 for dated references which are related to the standard as mentioned above)

**4.5 RESULT: PASSED**

Model Name	PBC-1000
Test Voltage	AC 230V/50Hz
Temperature:	26 °C
Humidity:	56 % RH

**4.6 TEST DATA:**

Please refer to APPENDIX 2



## 5. POWER HARMONIC MEASUREMENT

### 5.1 TEST SETUP

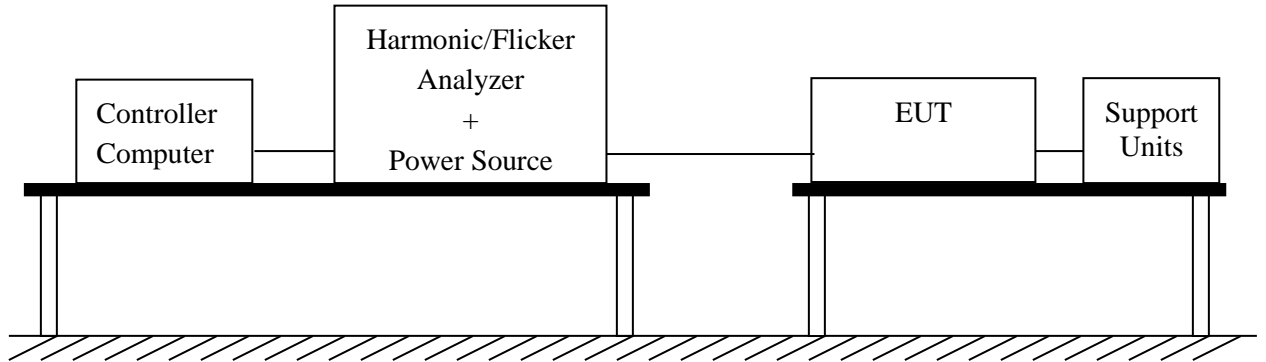

### 5.2 LIMITS

Limits for Class A equipment		Limits for Class D equipment		
Harmonic Order n	Maximum Permissible Harmonic Current A	Harmonic Order n	Maximum Permissible Harmonic Current A mAW	
Odd Harmonic		Odd Harmonic only		
3	2.30	3	2.30	3.4
5	1.14	5	1.14	1.9
7	0.77	7	0.77	1.0
9	0.40	9	0.40	0.5
11	0.33	11	0.33	0.35
13	0.21	13	0.21	0.30
15 ≤ n ≤ 39	0.15 x 15/n	15 ≤ n ≤ 39	0.15 x 15/n	3.85/n
Even Harmonic				
2	1.08			
4	0.43			
6	0.30			
8 ≤ n ≤ 40	0.23 x 8/n			

Note:

1. Class A and Class D are classified according to item section 5 of EN IEC 61000-3-2: 2019. According to section 7 of EN IEC 61000-3-2: 2019, the above limits for all equipment except for lighting equipment are for all applications having an active input power > 75 W and no limits apply for equipment with an active input power up to and including 75W.



**5.3 TEST PROCEDURE**

The EUT was operated to produce the maximum harmonic components under normal operating conditions.

The correspondent test program of test instrument to measure the current harmonics emanated from EUT is chosen. The measure time shall be not less than the time necessary for the EUT to be exercised.

**5.4 TEST SPECIFICATION**

According to EN IEC 61000-3-2

(Please refer to Page 5 for dated references which are related to the standard as mentioned above)

**5.5 RESULT: PASSED**

Model Name	PBC-1000
Test Voltage	AC 230V/50Hz
Temperature:	25 °C
Humidity:	50 % RH

**5.6 TEST DATA:**

Please refer to APPENDIX 2.





## 6. VOLTAGE FLUCTUATIONS

### 6.1 TEST SETUP

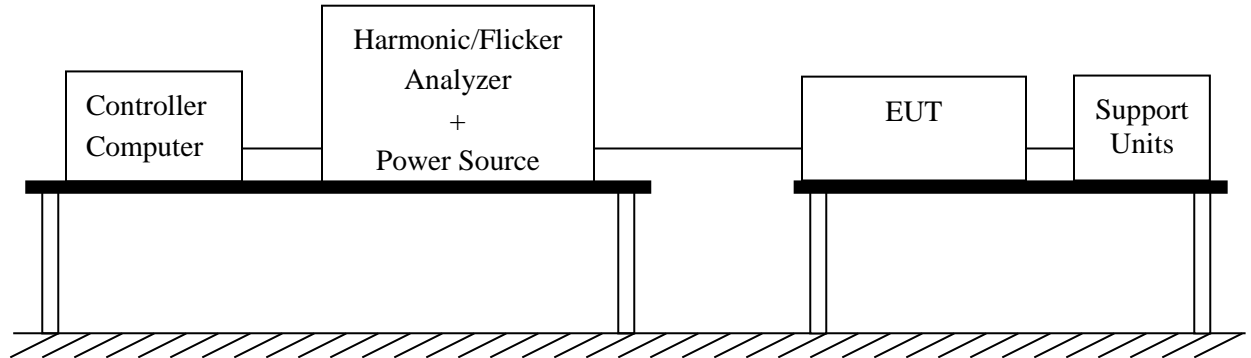

### 6.2 LIMITS

TEST ITEM	Limits	Descriptions
$P_{st}$	$\leq 1.0, T_p = 10 \text{ min.}$	Short Term Flicker Indicator
$P_{lt}$	$\leq 0.65, T_p = 2 \text{ hr.}$	Long Term Flicker Indicator
dc	$\leq 3.3\%$	Relative Steady-State V-Chang
$d_{max}$	$\leq 4\%$	Maximum Relative V-change
$d_{(t)}$	$\leq 3.3\% \text{ for } > 500\text{ms}$	Relative V-change characteristic

### 6.3 TEST PROCEDURE

Tests was performed according to the Test Conditions/Assessment of Voltage Fluctuations specified in EN 61000-3-3/IEC 61000-3-3 depend on which standard adopted for compliance measurement.

All types of harmonic current and/or voltage fluctuation in this report are assessed by direct measurement using flicker-meter.

### 6.4 TEST SPECIFICATION

According to EN 61000-3-3

(Please refers to Page 5 for dated references which are related to the standard as mentioned above)

### 6.5 RESULT: PASSED

Model Name	PBC-1000
Test Voltage	AC 230V/50Hz
Temperature:	25 °C
Humidity:	50 % RH

### 6.6 TEST DATA:

Please refer to APPENDIX 2.



## **7. PERFORMANCE CRITERIA**

A. The apparatus shall continue to operate as intended during and after the test. No degradation of performance or loss of function is allowed below a performance level specified by the manufacturer, when the apparatus is used as intended.

B. The apparatus shall continue to operate as intended after the test. No degradation of performance or loss of function is allowed below a performance level specified by the manufacturer, when the apparatus is used as intended. The performance level may be replaced by a permissible loss of performance. During the test, degradation of performance is however allowed.

C. Temporary loss of function is allowed, provided the function is self-recoverable or can be restored by the operation of the controls.



## 8. ELECTROSTATIC DISCHARGE IMMUNITY TEST (ESD)

### 8.1 TEST SETUP

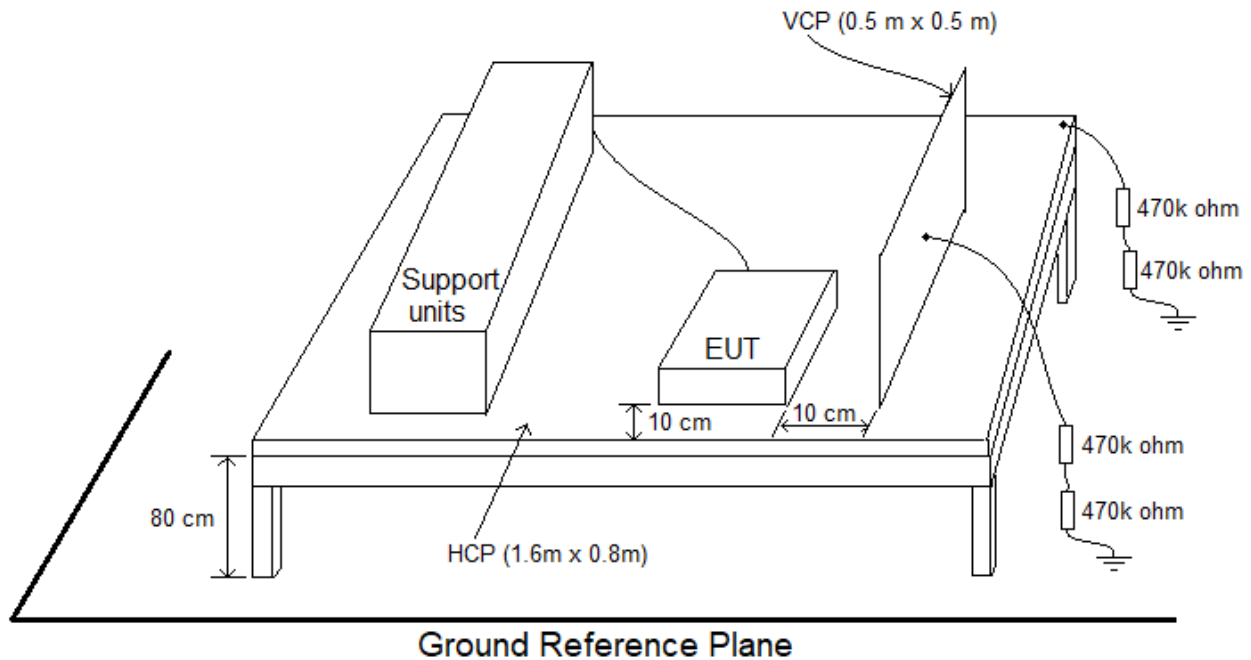

### 8.2 TEST SPECIFICATION

According to IEC 61000-4-2

(Please refer to Page 5 for dated references which are related to the standard as mentioned above)

### 8.3 TEST LEVEL

Item	Test Specification	Unit	Performance Criteria
Air Discharge	±2, 4, 8 (Direct)	kV (Charge Voltage)	B
Contact Discharge	±2,4 (Direct/Indirect)		
Discharge Period	1 (minimum)	sec	

Number of tests: 10 Discharges / Test point / Polarity / Level

### 8.4 TEST PROCEDURE

When the measurement was taken, The ESD discharger was performed in single discharge. For the single discharge time between successive single discharges will keep on one second. It was at least ten single discharges with positive and negative at the same selected pointed. The selected pointed, which was performed with electrostatic discharge, was marked on the red label on the EUT Indirect applicant of discharge to the EUT



## Vertical Coupling Plane (VCP)

The coupling plane, of dimensions 0.5 m x 0.5 m, is placed parallel to, and positioned at a distance 0.1 m from, the EUT, with the discharge electrode touching the coupling plane.

The four faces of the EUT will be performed with electrostatic discharge. It was at least ten singles discharges with positive and negative at the same selected point.

## Horizontal Coupling Plane (HCP)

The coupling plane is placed under the EUT. The generator shall be positioned vertically at a distance of 0.1m from the EUT, with the discharge electrode touching the coupling.

The four faces of the EUT will be performed with electrostatic discharge. It was at least ten single discharges with positive and negative at the same selected pointed.

## 8.5 TEST RESULT:

Model Name	PBC-1000
Test Voltage	AC 230V/50Hz
Temperature:	25 °C
Humidity:	50 % RH
Pressure	999.5 hPa

	Contact Discharge								Air Discharge									
	10 times / each								10 times / each									
Voltage	2kV		4kV		6kV		8kV		2kV		4kV		8kV		12kV		15kV	
Polarity	+	-	+	-	+	-	+	-	+	-	+	-	+	-	+	-	+	-
HCP	A	A	A	A	--	--	--	--	--	--	--	--	--	--	--	--	--	--
VCP	A	A	A	A	--	--	--	--	--	--	--	--	--	--	--	--	--	--
P <sub>1</sub> ~P <sub>4</sub>	--	--	--	--	--	--	--	--	A	A	A	A	A	A				
P <sub>5</sub> ~P <sub>20</sub>	A	A	A	A	--	--	--	--	--	--	--	--	--	--	--	--	--	--

### Note:

- 1) "--": denotes test is not applicable.
- 2) Criterion A: Normal performance within the specification.
- 3) Criterion B: Temporary degradation or less of function of performance which is self recoverable.
- 4) Criterion C: Temporary degradation or less of function or perform. Which requires. Operate intervention or system reset.

Final Result: **PASSED**

Photos of test configuration please refer to APPENDIX 1.

**Discharge points please refer below photos** (Red dot: Contact; Blue dot: Air)

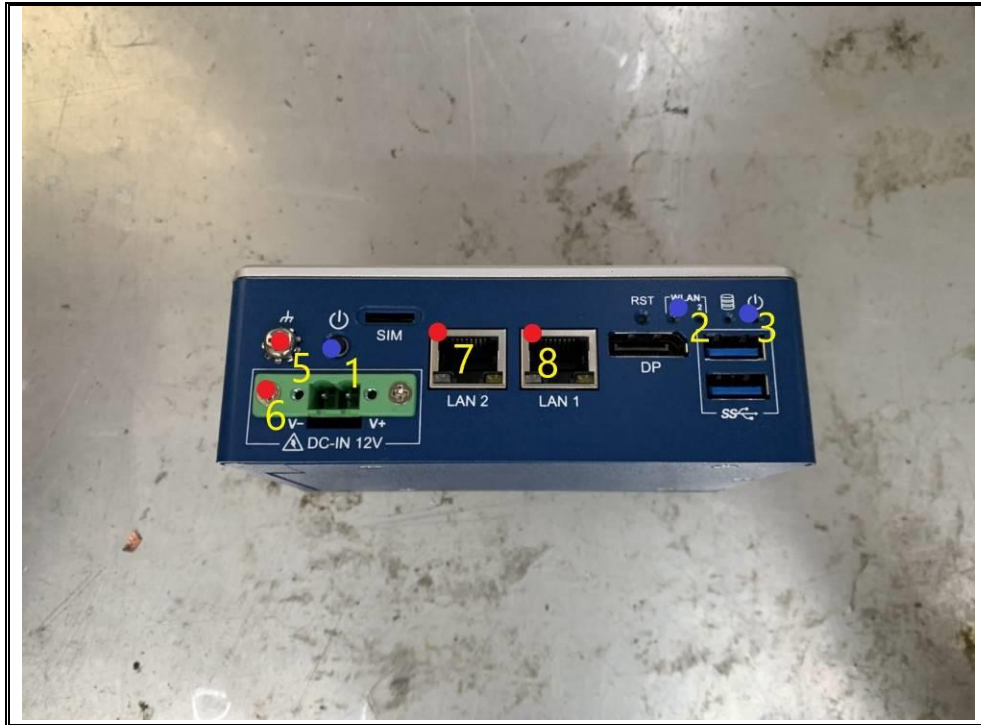
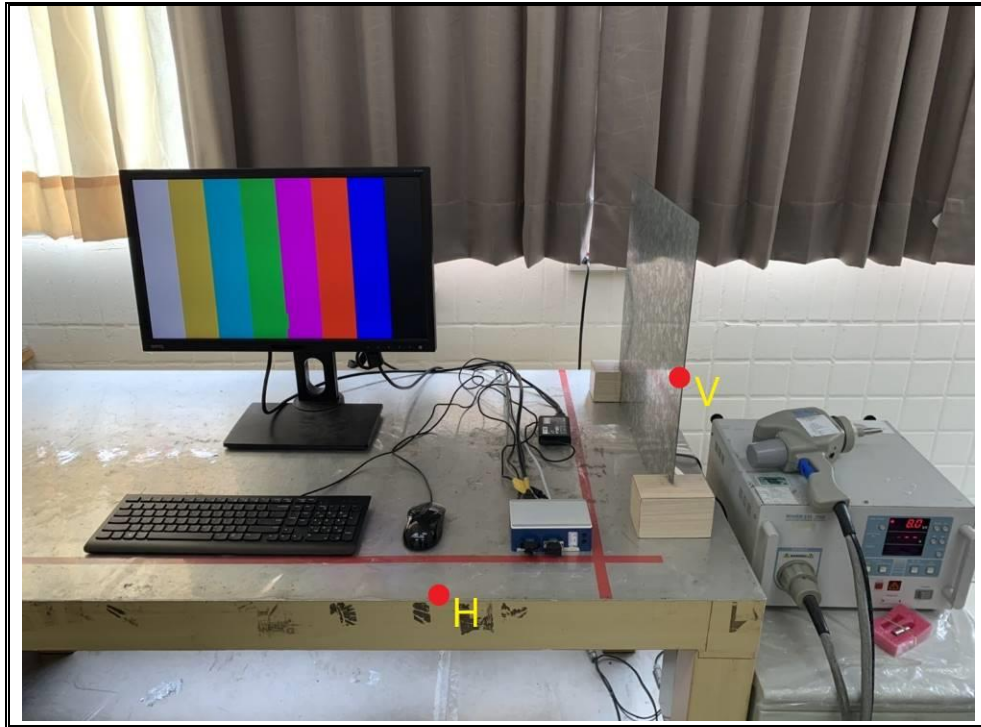



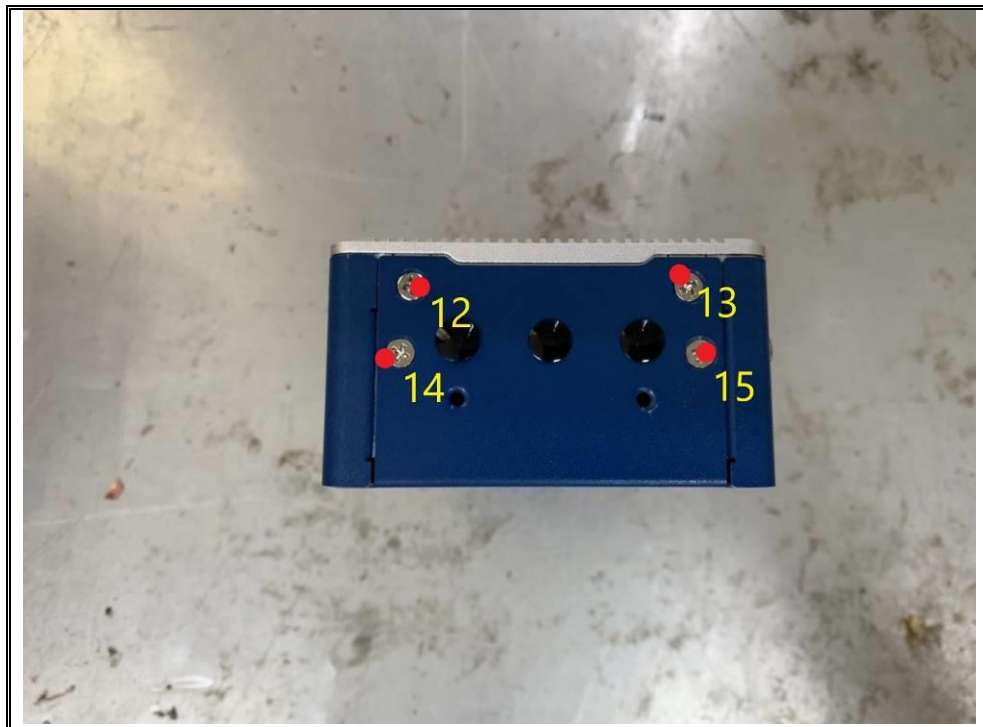
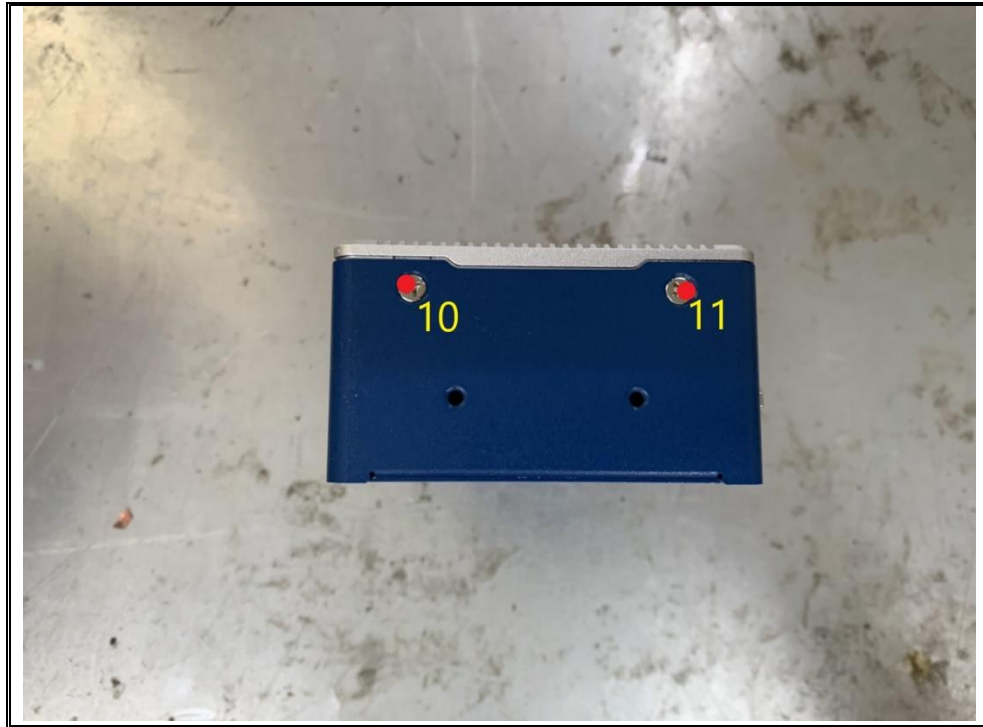

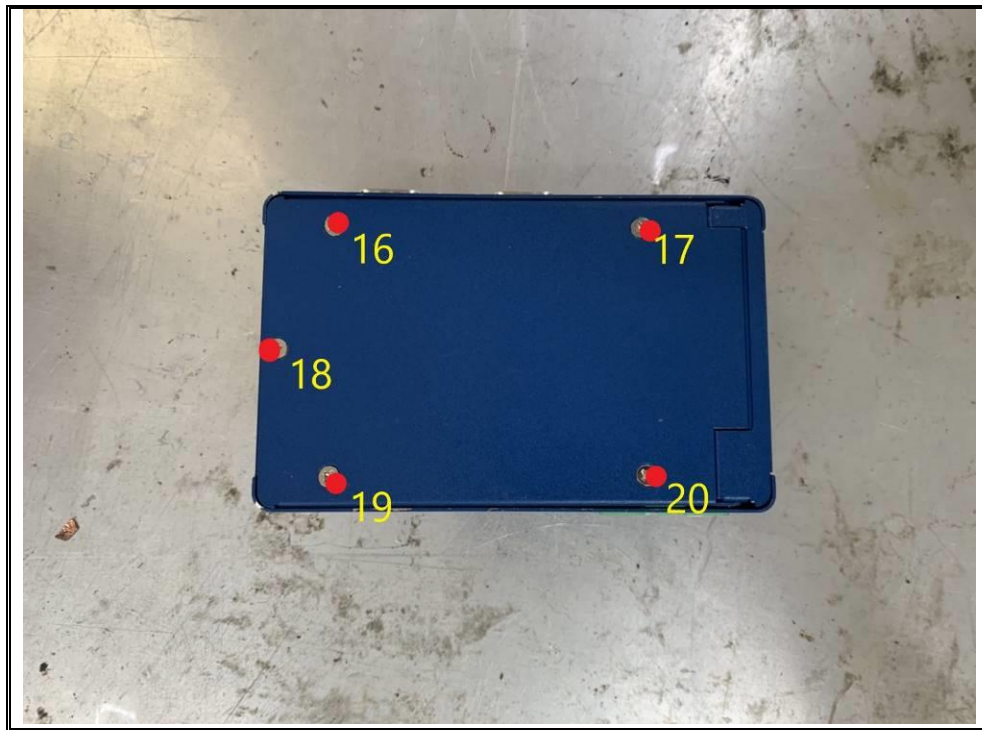





## 9. RADIATED SUSCEPTIBILITY MEASUREMENT (RS)

### 9.1 TEST SETUP

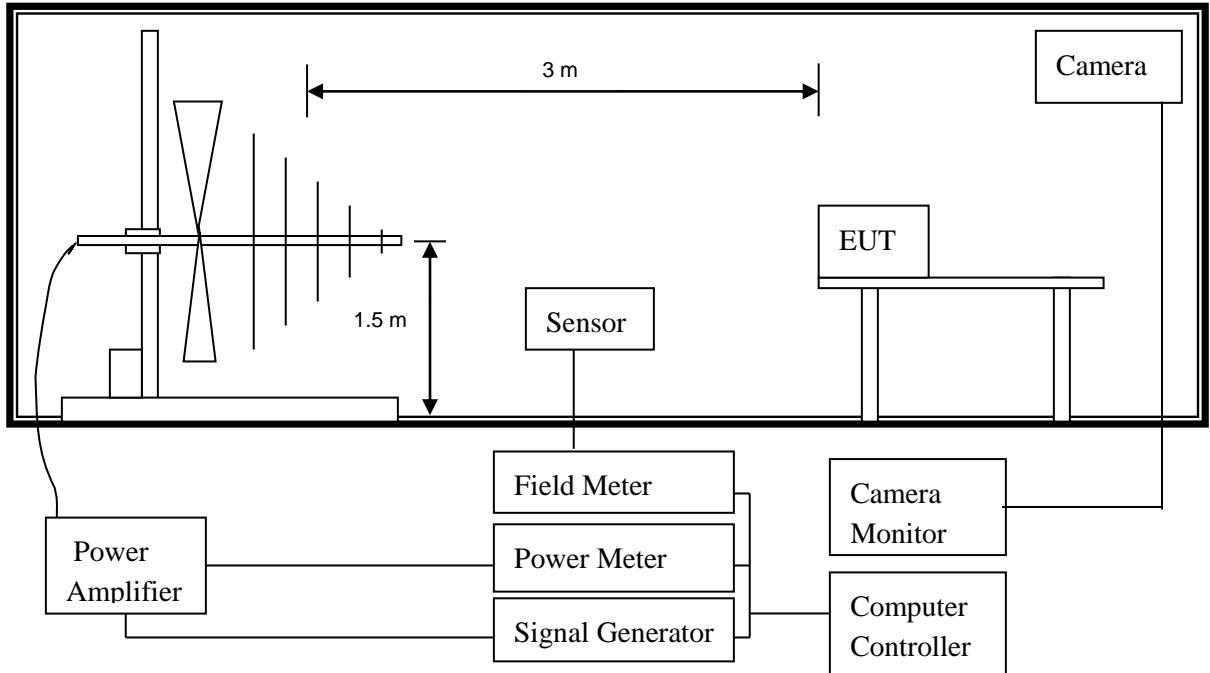

### 9.2 TEST SPECIFICATION

According to IEC 61000-4-3

(Please refer to Page 5 for dated references which are related to the standard as mentioned above)

### 9.3 TEST LEVEL

Item	Test Specification	Unit	Performance Criteria
Radio –Frequency	80~1000, 1800, 2600, 3500, 5000	MHz	A
Electromagnetic Field	3	V/m (unmodulated)	
Amplitude Modulated	80	%AM (1 kHz)	

### 9.1 TEST PROCEDURE

The EUT and load, which are placed on a wooden table whose height is 0.8 meter aboveground, are placed with one coincident with the calibration plane such that the distance from antenna to the EUT is 3 meters.

Both horizontal and vertical polarization of the antenna position and four sides of the EUT are set on measurement. In order to judge the EUT performance, a CCD camera is used to monitor the situation of EUT.

All the scanning conditions are as follows:



Condition of Test	
1. Field Strength	3 V/m
2. Radiated Signal	AM 80% modulated with 1 kHz
3. Scanning Frequencies	80 ~ 1000, 1800, 2600 ,3500, 5000 MHz
4. Dwell Time	3 seconds
5. Frequency step size	1%
6. Antenna Polarity	HORIZONTAL & VERTICAL
7. The four sides of EUT are tested	FRONT, REAR, RIGHT, LEFT

## 9.2 TEST RESULT:

Model Name	PBC-1000
Test Voltage	AC 230V/50Hz
Temperature:	25 °C
Humidity:	50 % RH

Polarity EUT Face	HORIZONTAL	VERTICAL	RESULT
FRONT	A	A	PASS
REAR	A	A	PASS
LEFT	A	A	PASS
RIGHT	A	A	PASS

### Note:

- 1)“--”: denotes test is not applicable.
- 2)Criterion A: Normal performance within the specification.
- 3)Criterion B: Temporary degradation or less of function of performance which is self recoverable.
- 4)Criterion C: Temporary degradation or less of function or perform. Which requires. Operate intervention or system reset.

Final Result: **PASSED**

Photos of test configuration please refer to APPENDIX 1.



## 10. ELECTRICAL FAST TRANSIENT/BURST (EFT)

### 10.1 TEST SETUP

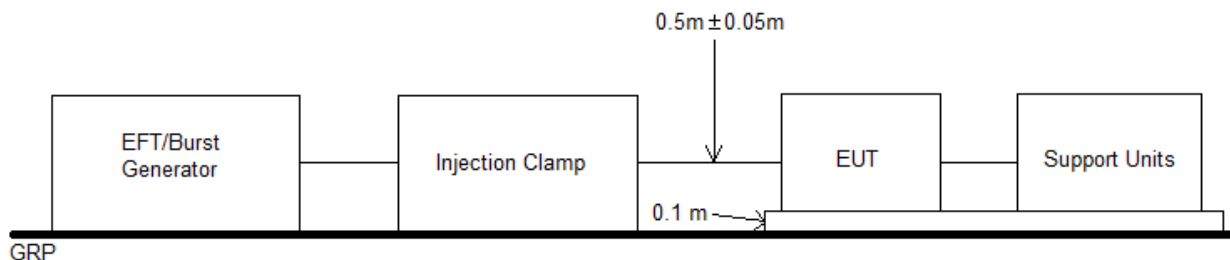
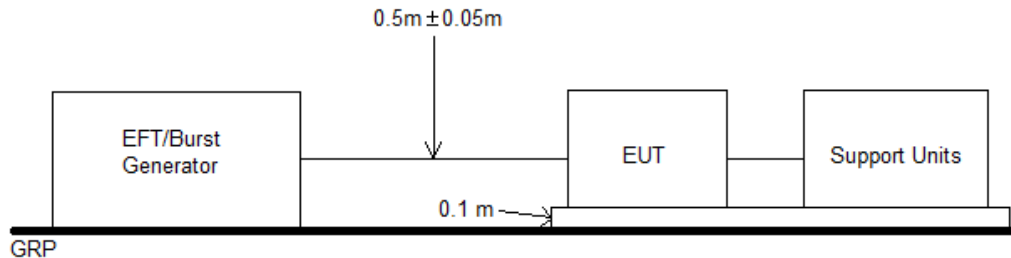

### 10.2 TEST SPECIFICATION

According to IEC 61000-4-4

(Please refer to Page 5 for dated references which are related to the standard as mentioned above)

### 10.3 TEST PROCEDURE

The EUT and load are placed on a ground reference plane and insulated from it by an insulating support  $0,1\text{ m} \pm 0,01\text{ m}$  thick. The minimum area of the ground reference plane is  $1\text{ m} \times 1\text{ m}$ . It also projected beyond the EUT by at least 0.1 meter on all sides.

For Input and Output AC power or DC Input and DC Output Power Ports:

The EUT is connected with the power mains through a coupling device that directly couples the EFT interference signal.

Each of the line and nature conductors is impressed with burst noise for 1 minute.

For Protective Earth Port:



The EUT is connected to the power mains through a coupling device that directly couples the EFT interference signal. The protective earth line (PE) is impressed with burst noise for 1 minute.

The length of power cord between the coupling device and the EUT shall be 0.5 m ± 0.05 m. For signal Lines and Control Lines Test:

The EFT interference signal is through a coupling clamp device couples to the signal and control lines of the EUT with burst noise for 1 minute.

**10.4 TEST LEVEL**

Item	Test Specification	Unit	Performance Criteria
Test Voltage	AC port: ±0.5, ±1 DC/Signal port: ±0.5	kV (Peak)	B
Impulse Wave-shape	5/50	ns (Tr/Ts)	
Repetition frequency	5	kHz	
Burst Duration	15	ms	
Burst Period	300	ms	
Test Duration	Not less than 1	mins	

**10.5 TEST RESULT:**

Model Name	PBC-1000
Test Voltage	AC 230V/50Hz
Temperature:	25 °C
Humidity:	50 % RH

Test Point/ Mode / Result		0.5 kV		1 kV		2 kV	
		+	-	+	-	+	-
Power Line	L	A	A	A	A	--	--
	N	A	A	A	A	--	--
	L+N	A	A	A	A	--	--
	PE	A	A	A	A	--	--
	L+PE	A	A	A	A	--	--
	N+PE	A	A	A	A	--	--
	L+N+PE	A	A	A	A	--	--
Signal Line Clamp Test		A	A	--	--	--	--



Note:

- 1) "--": denotes test is not applicable.
- 2) Criterion A: Normal performance within the specification.
- 3) Criterion B: Temporary degradation or less of function of performance which is self recoverable.
- 4) Criterion C: Temporary degradation or less of function or perform. Which requires. Operate intervention or system reset.

Final Result: **PASSED**

Photos of test configuration please refer to APPENDIX 1



## 11. SURGE

### 11.1 TEST SETUP

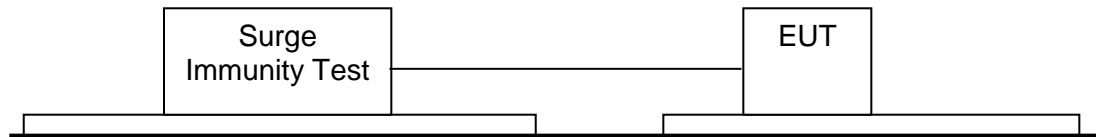

### 11.2 TEST SPECIFICATION

According to IEC 61000-4-5

(Please refer to Page 5 for dated references which are related to the standard as mentioned above)

### 11.3 TEST LEVEL

Item	Test Specification	Unit	Performance Criteria
DC Input and DC Output Power Ports			
Surge	1.2/50(8/20)	Tr/Ts (μs)	
Line to Ground	±0.5	kV	B
Line to Line	±0.5	kV	B
AC Input and AC Output Power Ports			
Surge	1.2/50(8/20)	Tr/Ts (μs)	
Line to Ground	±0.5, ±1, ±2	kV	B
Line to Line	±0.5, ±1	kV	B
Signal Ports			
Surge	10/700	Tr/Ts (μs)	
Line to Ground	±0.5, ±1	kV	C
Polarity	POSITIVE / NEGATIVE		
Pulse Repetition Rate	1 time / min (maximum)		

### 11.4 TEST PROCEDURE

The length of power cord between the coupling device and the EUT shall be 2 meters or less.

For Input and Output AC Power or DC Input and DC Output Power Ports:



The EUT is connected to the power mains through a coupling device that directly couples the Surge interference signal.

The Surge noise shall be applied synchronized to the voltage phase at 0°, 90°, 180°, 270° and the peak value of the AC voltage wave. (5 Positive and 5 Negative)

Each of line-earth and line-line is impressed with a sequence of five surge voltages with interval of 1 minute.

### 11.5 TEST RESULT:

Model Name	PBC-1000
Test Voltage	AC 230V/50Hz
Temperature:	25 °C
Humidity:	50 % RH

Power Port	Waveform: 1.2/50µs(8/20µs)		
Phase/Polarity/Mode/Result			Result
0.5 kV, 1 kV	+	Line to Neutral	A
	-		A
0.5 kV, 1 kV, 2 kV	+	Line to Ground	A
	-		A
	+	Neutral to Ground	A
	-		A
Signal Port	Waveform: 10/700µs		
Phase/Polarity/Mode			Result
0.5 kV, 1 kV	+	Line to Ground	A
	-		A

#### Note:

- 1) "--": denotes test is not applicable.
- 2) Criterion A: Normal performance within the specification.
- 3) Criterion B: Temporary degradation or less of function of performance which is self recoverable.
- 4) Criterion C: Temporary degradation or less of function or perform. Which requires. Operate intervention or system reset.

Final Result: **PASSED**

Photos of test configuration please refer to APPENDIX 1.



## 12. IMMUNITY TEST TO CS CONDUCTED DISTURBANCE (CS)

### 12.1 TEST SETUP

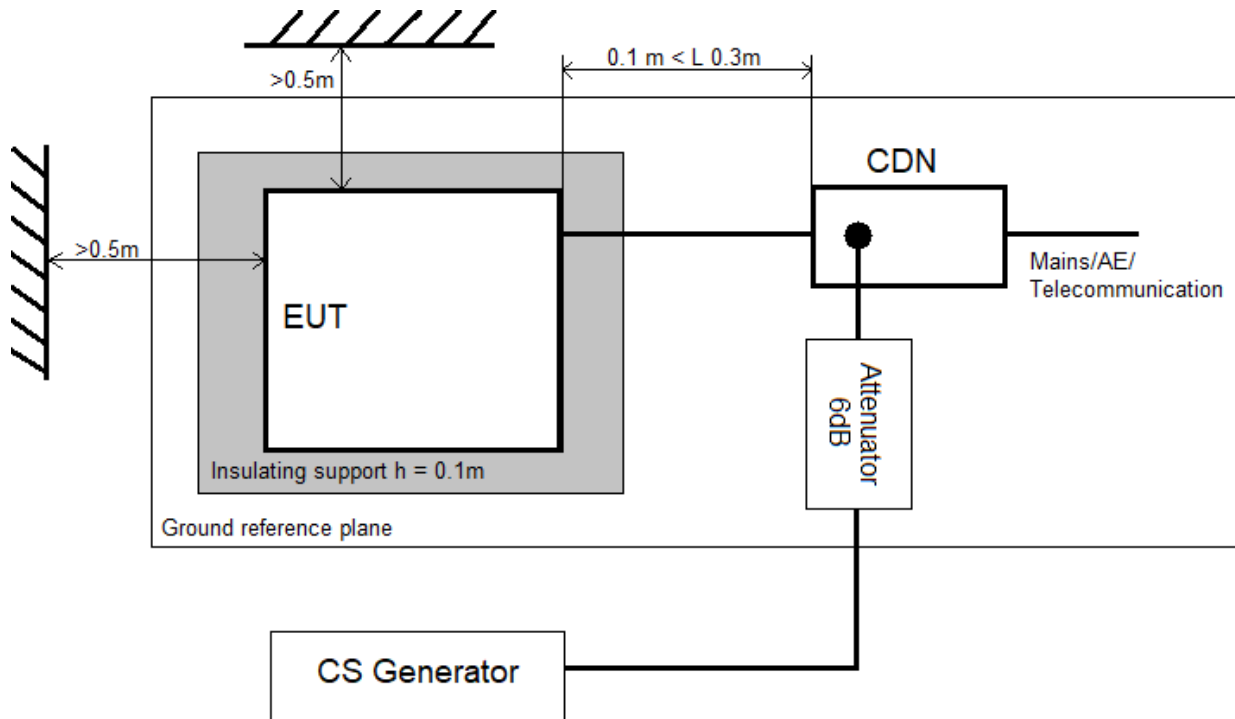

### 12.2 TEST SPECIFICATION

According to IEC 61000-4-6

(Please refer to Page 5 for dated references which are related to the standard as mentioned above)

### 12.3 TEST LEVEL

Item	Test Specification	Unit	Performance Criteria
Signal Port			
Frequency Range	0.15 ~ 10, 10 ~ 30, 30 ~ 80	MHz	A
Field Strength	3, 3 to 1, 1	Vrms (unmodulated)	
Amplitude Modulated	80	%AM (1 kHz)	
AC Input and AC Output and DC Input and DC output Ports and Functional Earth Ports			





	Frequency Range	0.15 ~ 10, 10 ~ 30, 30 ~ 80	MHz	A
	Field Strength	3, 3 to 1, 1	Vrms (unmodulated)	
	Amplitude Modulated	80	%AM (1 kHz)	

## 12.4 TEST PROCEDURE

The EUT are placed upon table and use 10cm insulation between the EUT and ground reference plane.

For AC Input and AC Output Power or DC Input and DC Output Power Ports:

The EUT is connected to the power mains through a coupling and decoupling network for Power supply lines. It also directly couples the disturbance signal into EUT.

Use CDN-M2 for two wires or CDN-M3 for three wires.

For Signal Lines and Control Lines Test:

The disturbance signal is through a coupling and decoupling networks (CDN) or EM-clamp which is to couple the signal and control lines of the EUT.

All scanning frequencies conditions are as following:

Condition of Test	
1. Field Strength	3 V, 3 to 1 V, 1 V
2. Radiated Signal	AM 80% modulated with 1 kHz
3. Scanning Frequencies	0.15 ~ 10 MHz, 10 ~ 30MHz, 30 ~ 80MHz
4. Dwell Time	3 seconds
5. Frequency step size	1%
6. The rate of swept of frequency	$1.5 \times 10^{-3}$ decades/s

## 12.5 TEST RESULT:

Model Name	PBC-1000
Test Voltage	AC 230V/50Hz
Temperature:	25 °C
Humidity:	50 % RH

Test Ports	Frequency Range (MHz)	Field Strength (Vrms)	Result
Power Port	0.15 ~ 10, 10 ~ 30, 30 ~ 80	3, 3 to 1, 1	A



---

Signal Port	0.15 ~ 10, 10 ~ 30, 30 ~ 80	3, 3 to 1, 1	A
-------------	-----------------------------------	--------------------	---

**Note:**

1) "--": denotes test is not applicable.

2) Criterion A: Normal performance within the specification.

3) Criterion B: Temporary degradation or less of function of performance which is self recoverable.

4) Criterion C: Temporary degradation or less of function or perform. Which requires. Operate intervention or system reset.

Final Result: **PASSED**

Photos of test configuration please refer to APPENDIX 1



### 13. POWER FREQUENCY MAGNETIC FIELD (PFMF)

#### 13.1 TEST SETUP

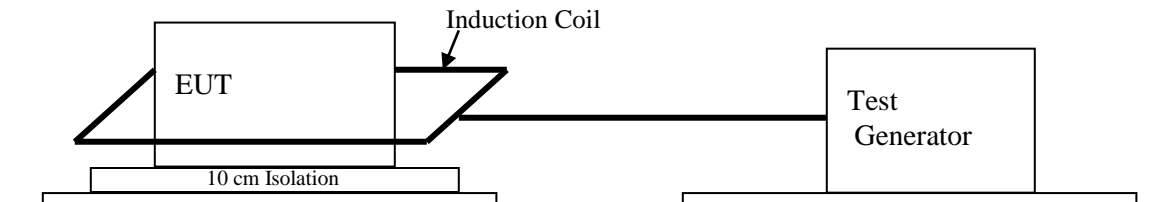

#### 13.2 TEST SPECIFICATION

According to IEC 61000-4-8

(Please refer to Page 5 for dated references which are related to the standard as mentioned above)

#### 13.3 TEST LEVEL

Item	Test Specification	Unit	Performance Criteria
Power-Frequency	50/60	Hz	A
Magnetic Field	1	A/m	
Observation Time	1	min	
Inductance Coil	1x1 (Rectangular type)	m	

#### 13.4 TEST PROCEDURE

The inductive coil is at least 1 meter x 1 meter, and 0.65mm minimum thickness.

The test magnetic field shall be applied by the immersion method to the EUT, and all cables shall be exposed to the magnetic field for 1 m of their length.

The induction coil shall be rotated by 90° in order to expose the EUT to the test field with different orientation (X, Y, Z orientation).

#### 13.5 TEST RESULT

Model Name	PBC-1000
Test Voltage	AC 230V/50Hz
Temperature:	25 °C
Humidity:	50 % RH



Direction	Field Strength (A/m)	Duration (s)	Result
X	1	60	A
Y	1	60	A
Z	1	60	A

**Note:**

- 1) "--": denotes test is not applicable.
- 2) Criterion A: Normal performance within the specification.
- 3) Criterion B: Temporary degradation or less of function of performance which is self recoverable.
- 4) Criterion C: Temporary degradation or less of function or perform. Which requires. Operate intervention or system reset.

Final Result: **PASSED**

Photos of test configuration please refer to APPENDIX 1.



## 14. VOLTAGE DIPS AND INTERRUPTION MEASUREMENT(DIPS)

### 14.1 TEST SETUP

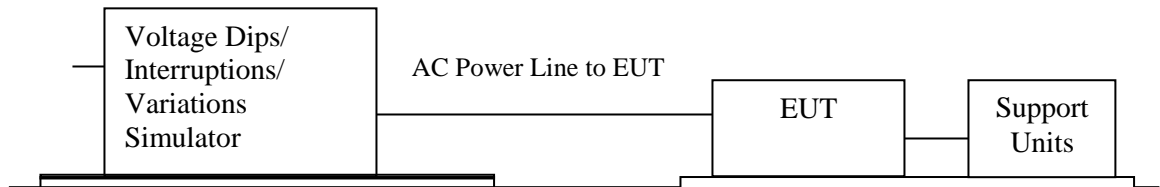

### 14.2 TEST SPECIFICATION

According to IEC 61000-4-11

(Please refer to Page 5 for dated references which are related to the standard as mentioned above)

### 14.3 TEST LEVEL

Class <sup>a</sup>	Test level and durations for voltage dips				
Class 1	Case-by-case according to the equipment requirements				
Class 2	0 % during 1/2 cycle	0 % during 1 cycle	70 % during 25/30 <sup>c</sup> cycles		
Class 3	0 % during 1/2 cycle	0 % during 1 cycle	40 % during 10/12 <sup>c</sup> cycles	70 % during 25/30 <sup>c</sup> cycles	80 % during 250/300 <sup>c</sup> cycles
Class X <sup>b</sup>	X	X	X	X	X

a: Classes as per IEC 61000-2-4.

b: To be defined by product committee. For equipment connected directly or indirectly to the public network, the levels must not be less severe than Class 2.

c: "25/30 cycles" means "25 cycles for 50 Hz test" and "30 cycles for 60 Hz test".

Class <sup>a</sup>	Test level and durations for short interruptions (t <sub>s</sub> ) (50Hz / 60Hz)
Class 1	Case-by-case according to the equipment requirements
Class 2	0 % during 250/300 <sup>c</sup> cycles
Class 3	0 % during 250/300 <sup>c</sup> cycles
Class X <sup>b</sup>	X

a: Classes as per IEC 61000-2-4.

b: To be defined by product committee. For equipment connected directly or indirectly to the public network, the levels must not be less severe than Class 2.

c: "250/300 cycles" means "250 cycles for 50 Hz test" and "300 cycles for 60 Hz test".



**14.4 TEST PROCEDURE**

The power cord shall be used the shortest power cord as specified by the manufacturer.

For Voltage Dips / Interruption Test:

The EUT is connected to the power mains through a coupling device that directly couples to the Voltage Dips and Interruption Generator.

The EUT shall be tested for 95% voltage dips of supplied voltage and duration time is 10ms, for 30% voltage dips of supplied voltage and duration time is 500ms with a sequence of three voltage dips with intervals of 10 seconds, and for 95% voltage interruption of supplied voltage and the duration time is 5000ms with a sequence of three voltage interruptions with intervals of 10 seconds.

Voltage phase shifting are shall occur at 0°, 45°, 90°, 135°, 180°, 225°, 270°, 315° of the voltage.

**14.5 TEST RESULT:**

Model Name	PBC-1000
Test Voltage	AC 230V/50Hz
Temperature:	25 °C
Humidity:	50 % RH

Voltage Dips	Test Level % U <sub>T</sub>	Reduction (%)	Duration	Performance Criteria
	<5	>95	0.5 (periods)	B
	70	30	25 (periods)	C

Voltage Interruptions	Test Level % U <sub>T</sub>	Reduction (%)	Duration	Performance Criteria
	<5	>95	250 (periods)	C

Note:

- 1) "--": denotes test is not applicable.
- 2) Criterion A: Normal performance within the specification.
- 3) Criterion B: Temporary degradation or less of function of performance which is self recoverable.
- 4) Criterion C: Temporary degradation or less of function or perform. Which requires. Operate intervention or system reset.

Final Result: **PASSED**

Please refer to APPENDIX 1



**15. MEASUREMENT UNCERTAINTY**

Measurement Item	Measurement Frequency	Polarization	Uncertainty
Conducted Emission	9 kHz ~ 30 MHz	LINE/NEUTRAL	3.54 dB
Conducted Emission at telecommunication ports	150 kHz ~ 30 MHz	/	3.36 dB
Radiated Emission	Below 1GHz	Horizontal	2.81 dB
		Vertical	4.01 dB
	Above 1GHz	Horizontal	4.64 dB
		Vertical	5.16 dB

Measurement Item		Uncertainty
Harmonic/Flicker emissions	Harmonic	0.54 %
	Voltage	0.5 %
	Flicker	4.96 %



**APPENDIX 1**  
**PHOTOS OF TEST CONFIGURATION**  
**Conducted Emission Test Setup**







**ISN Test Setup**





### Radiated Emission Test Setup





**ESD Test Setup**

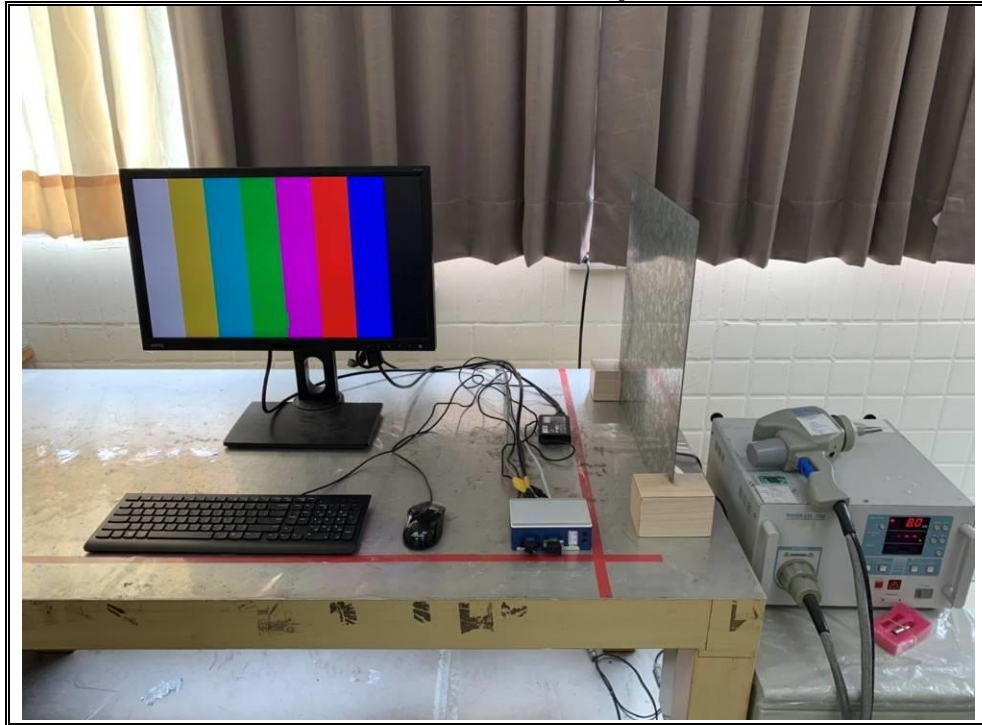

**RS Test Setup**

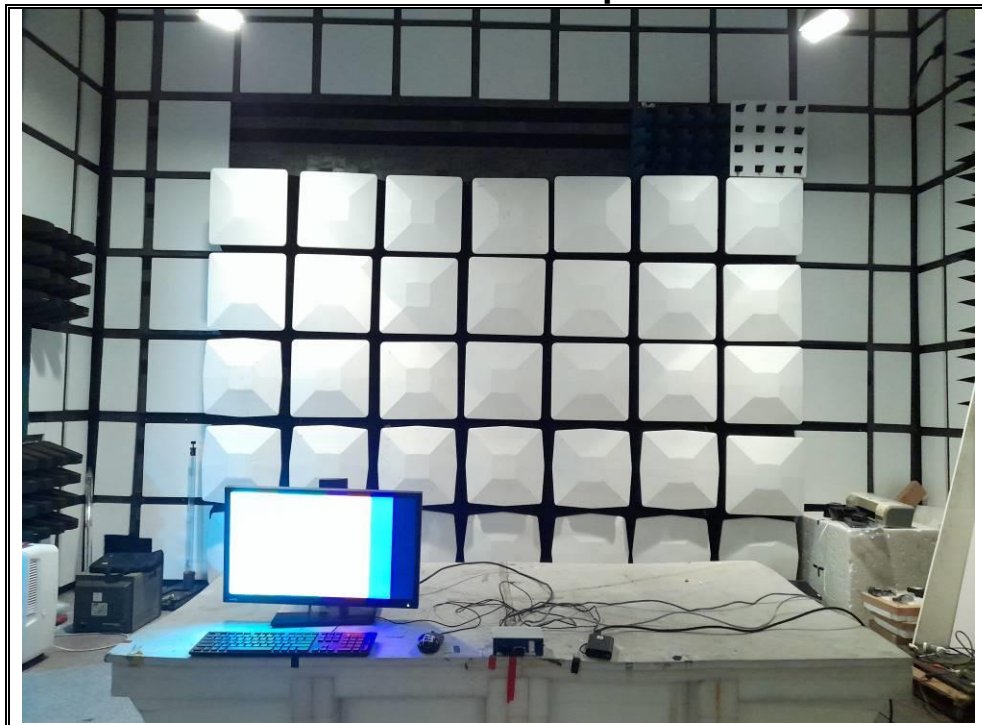



**EFT & DIPS Test Setup**



**EFT CLAMP Test Setup**

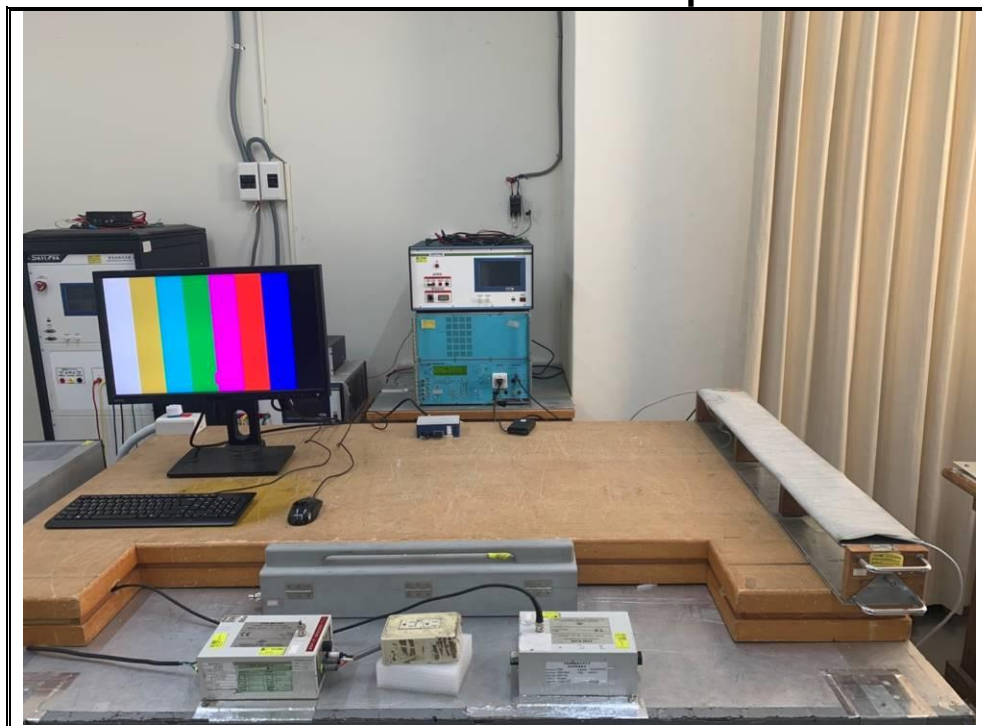



**SURGE Test Setup**



**SURGE LAN Test Setup**





**CS Test Setup**



**CS LAN Test Setup**





**PFMF Test Setup**

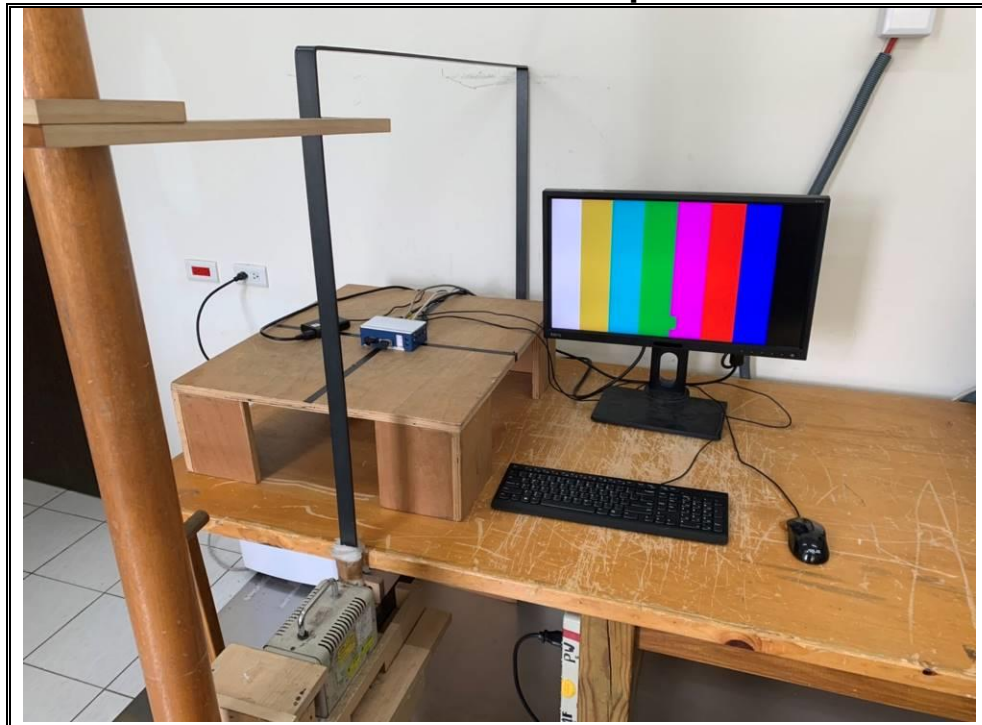

**Power Harmonic / Voltage Fluctuations Test Setup**

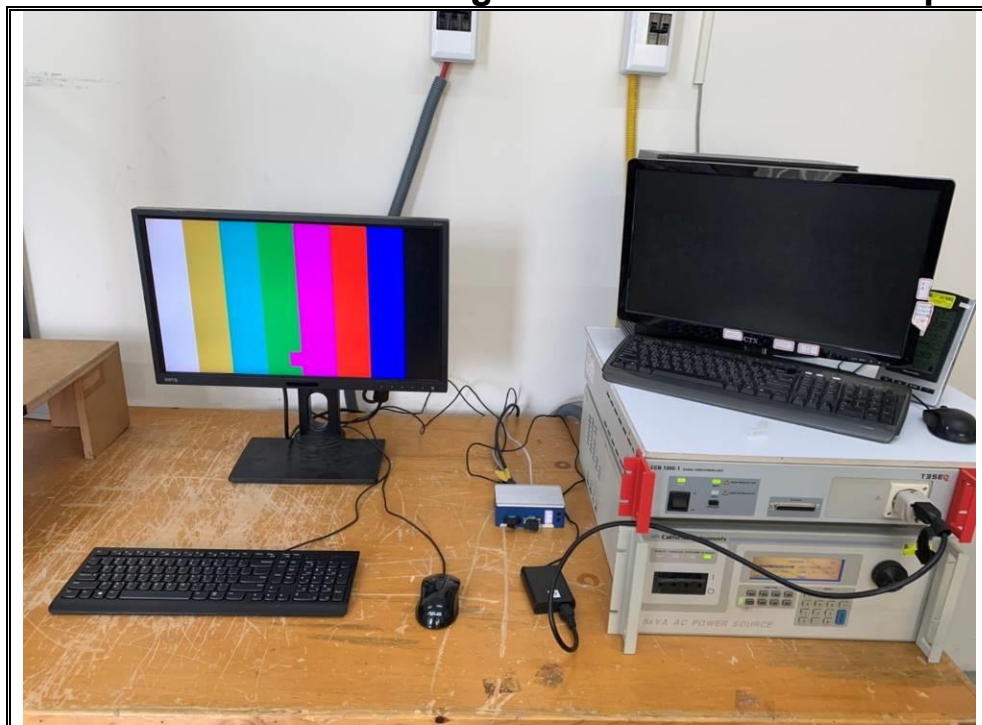



## APPENDIX 2 TEST DATA

### Test Data – Conducted Emission

Phase: L

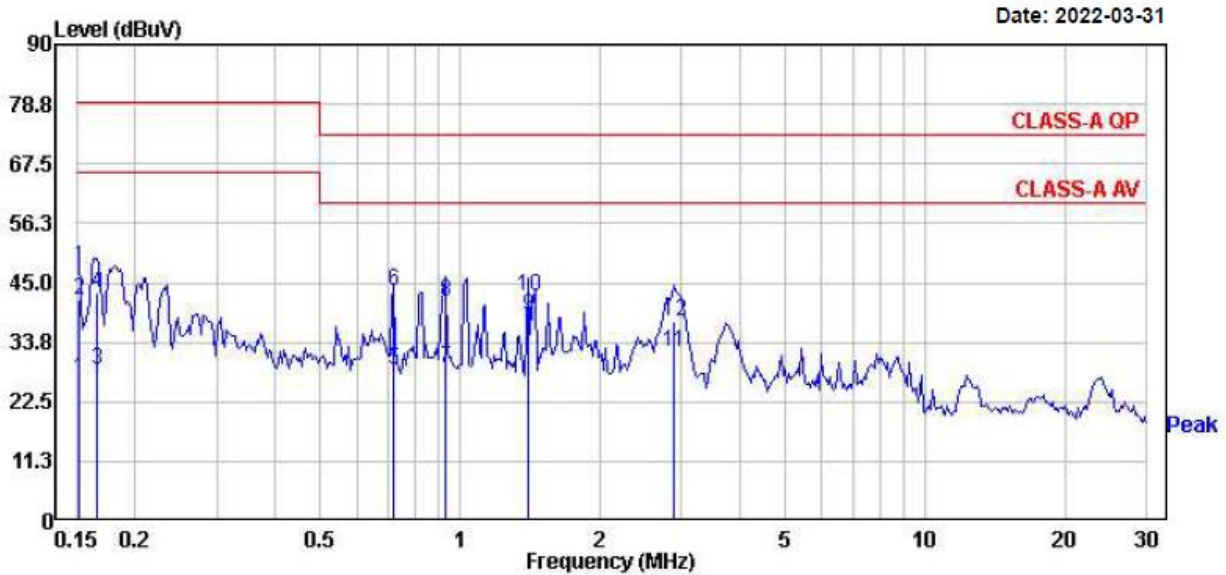

	Freq	Read Level	Factor	Level	Limit Line	Over Limit	Remark
	MHz	dBuV	dB	dBuV	dBuV	dB	
1	0.152	26.90	0.10	27.00	66.00	-39.00	Average
2	0.152	41.74	0.10	41.84	79.00	-37.16	QP
3	0.165	28.52	0.10	28.62	66.00	-37.38	Average
4	0.165	42.94	0.10	43.04	79.00	-35.96	QP
5	0.720	28.52	0.12	28.64	60.00	-31.36	Average
6	0.720	43.38	0.12	43.50	73.00	-29.50	QP
7	0.928	28.60	0.13	28.73	60.00	-31.27	Average
8	0.928	41.14	0.13	41.27	73.00	-31.73	QP
9	1.403	38.68	0.16	38.84	60.00	-21.16	Average
10	1.403	42.18	0.16	42.34	73.00	-30.66	QP
11	2.884	31.84	0.23	32.07	60.00	-27.93	Average
12	2.884	37.60	0.23	37.83	73.00	-35.17	QP





Phase: N

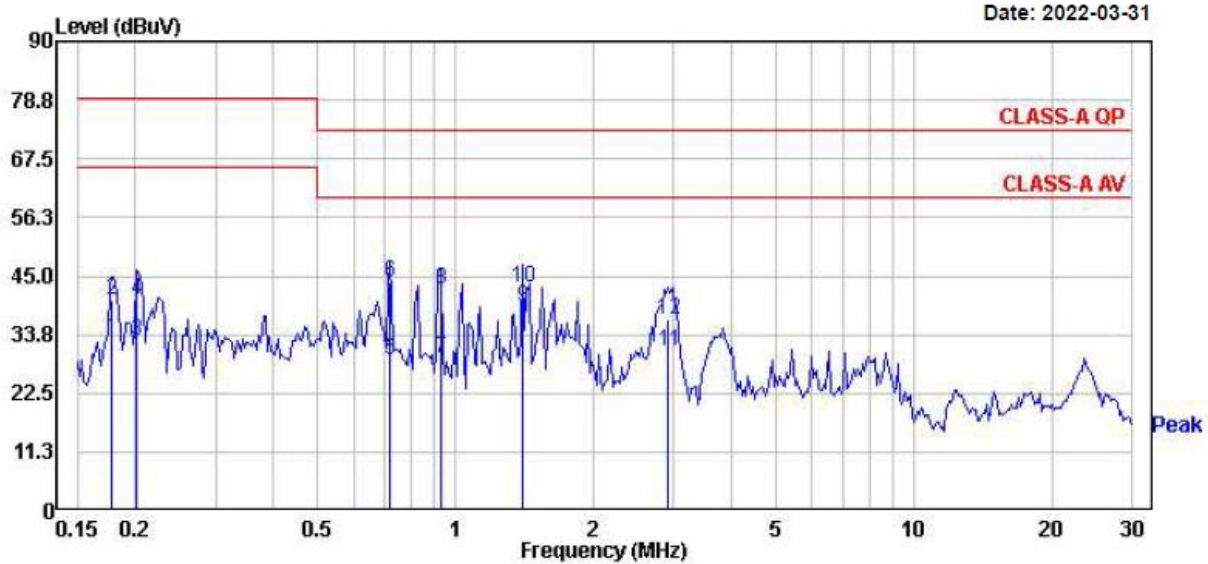

	Read Freq	Read Level	Factor	Limit Level	Over Limit	Remark
	MHz	dBuV	dB	dBuV	dB	
1	0.178	32.77	0.09	32.86	66.00	-33.14 Average
2	0.178	40.46	0.09	40.55	79.00	-38.45 QP
3	0.202	32.66	0.09	32.75	66.00	-33.25 Average
4	0.202	40.30	0.09	40.39	79.00	-38.61 QP
5	0.720	28.60	0.12	28.72	60.00	-31.28 Average
6	0.720	43.54	0.12	43.66	73.00	-29.34 QP
7	0.928	29.17	0.13	29.30	60.00	-30.70 Average
8	0.928	42.18	0.13	42.31	73.00	-30.69 QP
9	1.403	38.79	0.16	38.95	60.00	-21.05 Average
10	1.403	42.50	0.16	42.66	73.00	-30.34 QP
11	2.915	30.27	0.23	30.50	60.00	-29.50 Average
12	2.915	36.60	0.23	36.83	73.00	-36.17 QP



**Test Data – ISN**

**LAN1 10Mbps**

Date: 2022-03-31

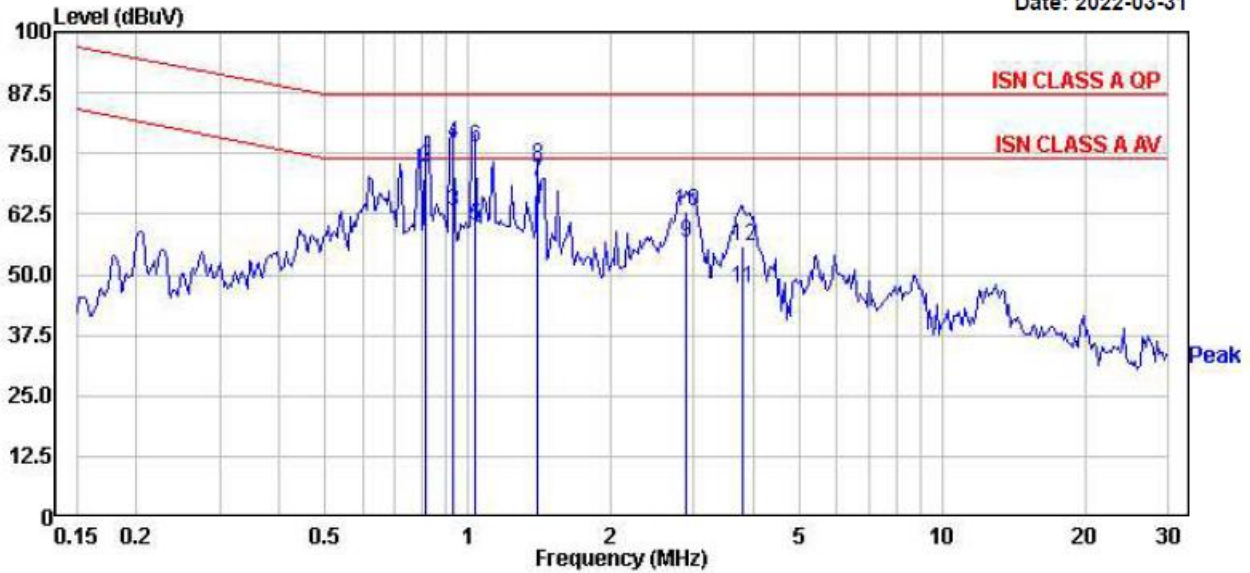

	Read Freq	Read Level	Read Factor	Limit Level	Over Limit	Remark
	MHz	dBuV	dB	dBuV	dB	
1	0.817	48.84	9.58	58.42	74.00	-15.58 Average
2	0.817	62.40	9.58	71.98	87.00	-15.02 QP
3	0.928	53.53	9.55	63.08	74.00	-10.92 Average
4	0.928	67.34	9.55	76.89	87.00	-10.11 QP
5	1.032	50.47	9.54	60.01	74.00	-13.99 Average
6	1.032	66.86	9.54	76.40	87.00	-10.60 QP
7	1.403	59.43	9.52	68.95	74.00	-5.05 Average
8	1.403	63.12	9.52	72.64	87.00	-14.36 QP
9	2.884	47.08	9.47	56.55	74.00	-17.45 Average
10	2.884	53.70	9.47	63.17	87.00	-23.83 QP
11	3.799	37.82	9.47	47.29	74.00	-26.71 Average
12	3.799	46.46	9.47	55.93	87.00	-31.07 QP



LAN1 100Mbps

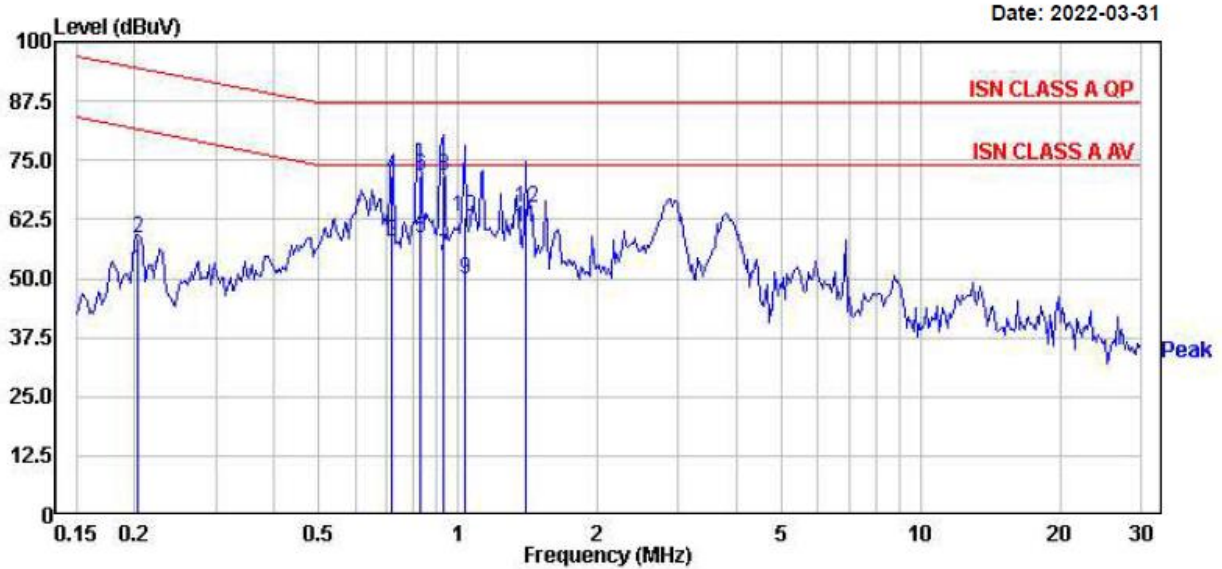

	Read Freq	Read Level	Factor	Level	Limit Line	Over Limit	Remark
	MHz	dBuV	dB	dBuV	dBuV	dB	
1	0.204	41.90	9.90	51.80	81.45	-29.65	Average
2	0.204	48.44	9.90	58.34	94.45	-36.11	QP
3	0.720	48.25	9.59	57.84	74.00	-16.16	Average
4	0.720	62.00	9.59	71.59	87.00	-15.41	QP
5	0.826	49.09	9.57	58.66	74.00	-15.34	Average
6	0.826	62.06	9.57	71.63	87.00	-15.37	QP
7	0.928	45.34	9.55	54.89	74.00	-19.11	Average
8	0.928	62.02	9.55	71.57	87.00	-15.43	QP
9	1.032	40.20	9.54	49.74	74.00	-24.26	Average
10	1.032	53.62	9.54	63.16	87.00	-23.84	QP
11	1.403	51.21	9.52	60.73	74.00	-13.27	Average
12	1.403	55.26	9.52	64.78	87.00	-22.22	QP



## LAN1 1Gbps

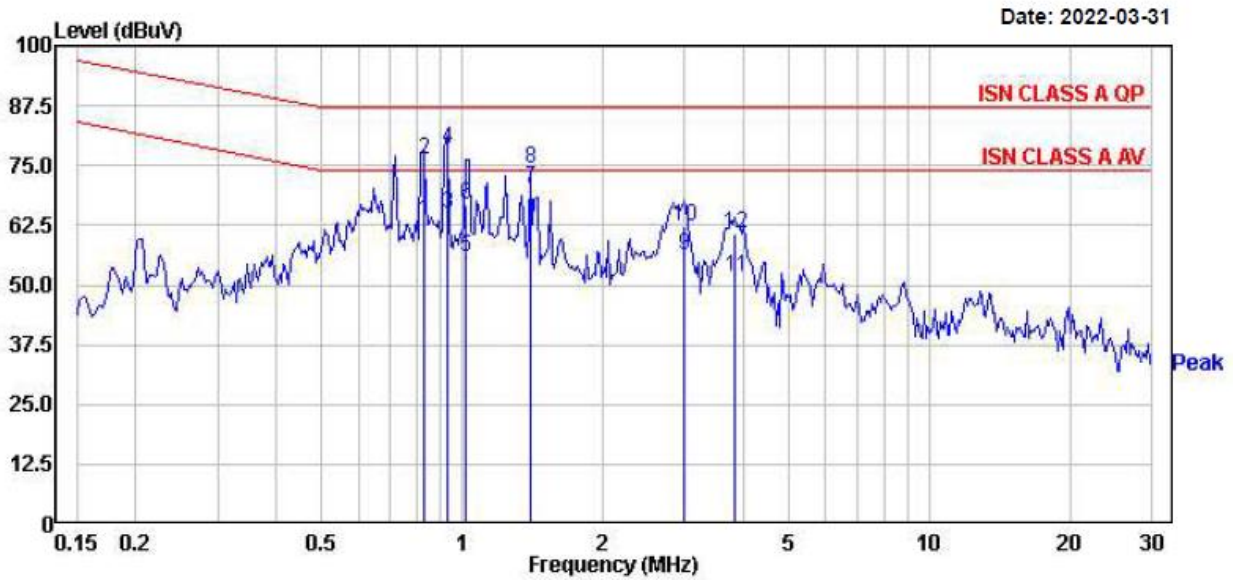

	Read Freq	Read Level	Factor	Limit Level	Over Limit	Remark
	MHz	dBuV	dB	dBuV	dB	
1	0.826	53.76	9.57	63.33	74.00	-10.67 Average
2	0.826	66.72	9.57	76.29	87.00	-10.71 QP
3	0.928	55.50	9.55	65.05	74.00	-8.95 Average
4	0.928	69.00	9.55	78.55	87.00	-8.45 QP
5	1.021	46.49	9.54	56.03	74.00	-17.97 Average
6	1.021	57.26	9.54	66.80	87.00	-20.20 QP
7	1.403	60.72	9.52	70.24	74.00	-3.76 Average
8	1.403	64.98	9.52	74.50	87.00	-12.50 QP
9	2.978	46.69	9.47	56.16	74.00	-17.84 Average
10	2.978	52.92	9.47	62.39	87.00	-24.61 QP
11	3.840	42.34	9.47	51.81	74.00	-22.19 Average
12	3.840	51.12	9.47	60.59	87.00	-26.41 QP



LAN2 10Mbps

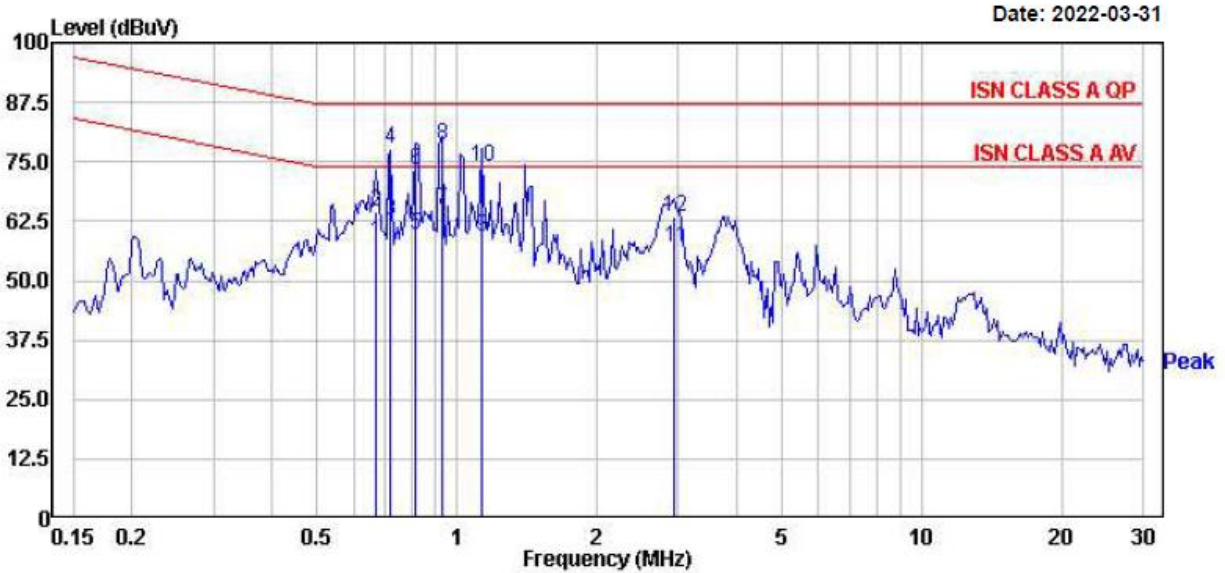

	Read Freq	Read Level	Factor	Limit Level	Over Limit	Remark
	MHz	dBuV	dB	dBuV	dB	
1	0.668	48.68	9.61	58.29	74.00	-15.71 Average
2	0.668	54.80	9.61	64.41	87.00	-22.59 QP
3	0.720	53.16	9.59	62.75	74.00	-11.25 Average
4	0.720	68.22	9.59	77.81	87.00	-9.19 QP
5	0.817	50.21	9.58	59.79	74.00	-14.21 Average
6	0.817	63.50	9.58	73.08	87.00	-13.92 QP
7	0.928	55.26	9.55	64.81	74.00	-9.19 Average
8	0.928	69.00	9.55	78.55	87.00	-8.45 QP
9	1.135	49.66	9.54	59.20	74.00	-14.80 Average
10	1.135	64.35	9.54	73.89	87.00	-13.11 QP
11	2.946	47.57	9.47	57.04	74.00	-16.96 Average
12	2.946	54.00	9.47	63.47	87.00	-23.53 QP



## LAN2 100Mbps

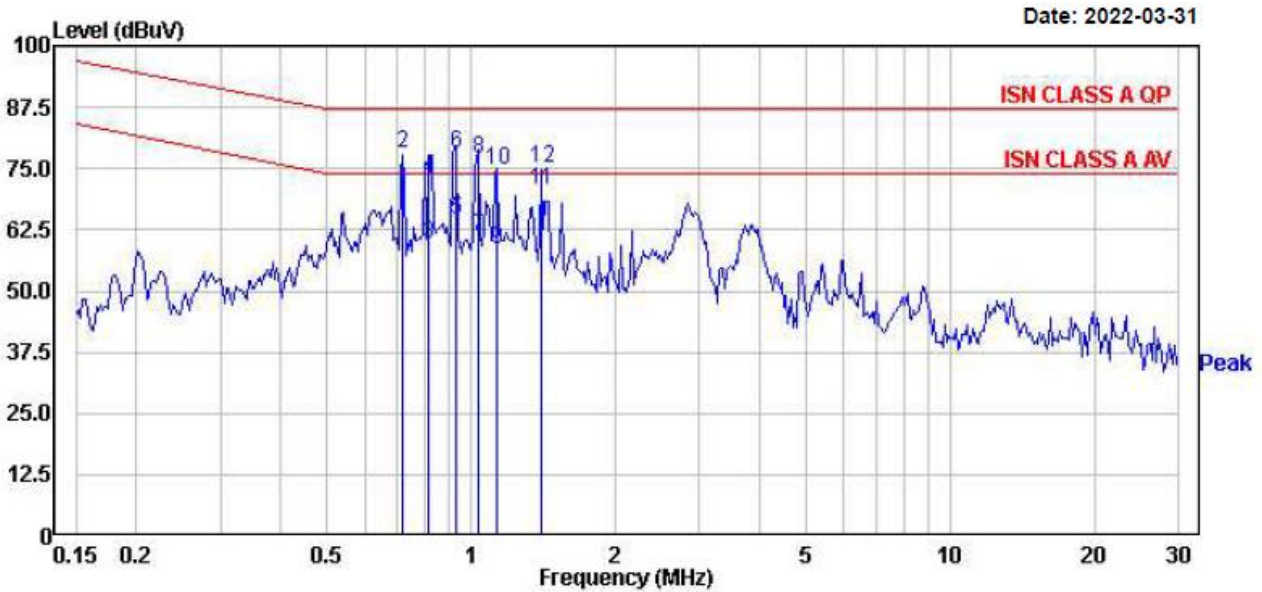

	Read Freq	Read Level	Factor	Level	Limit Line	Over Limit	Remark
	MHz	dBuV	dB	dBuV	dBuV	dB	
1	0.720	52.91	9.59	62.50	74.00	-11.50	Average
2	0.720	68.48	9.59	78.07	87.00	-8.93	QP
3	0.817	49.99	9.58	59.57	74.00	-14.43	Average
4	0.817	63.28	9.58	72.86	87.00	-14.14	QP
5	0.928	55.06	9.55	64.61	74.00	-9.39	Average
6	0.928	68.70	9.55	78.25	87.00	-8.75	QP
7	1.032	51.74	9.54	61.28	74.00	-12.72	Average
8	1.032	67.48	9.54	77.02	87.00	-9.98	QP
9	1.135	48.93	9.54	58.47	74.00	-15.53	Average
10	1.135	65.19	9.54	74.73	87.00	-12.27	QP
11	1.403	61.13	9.52	70.65	74.00	-3.35	Average
12	1.403	65.64	9.52	75.16	87.00	-11.84	QP



## LAN2 1Gbps

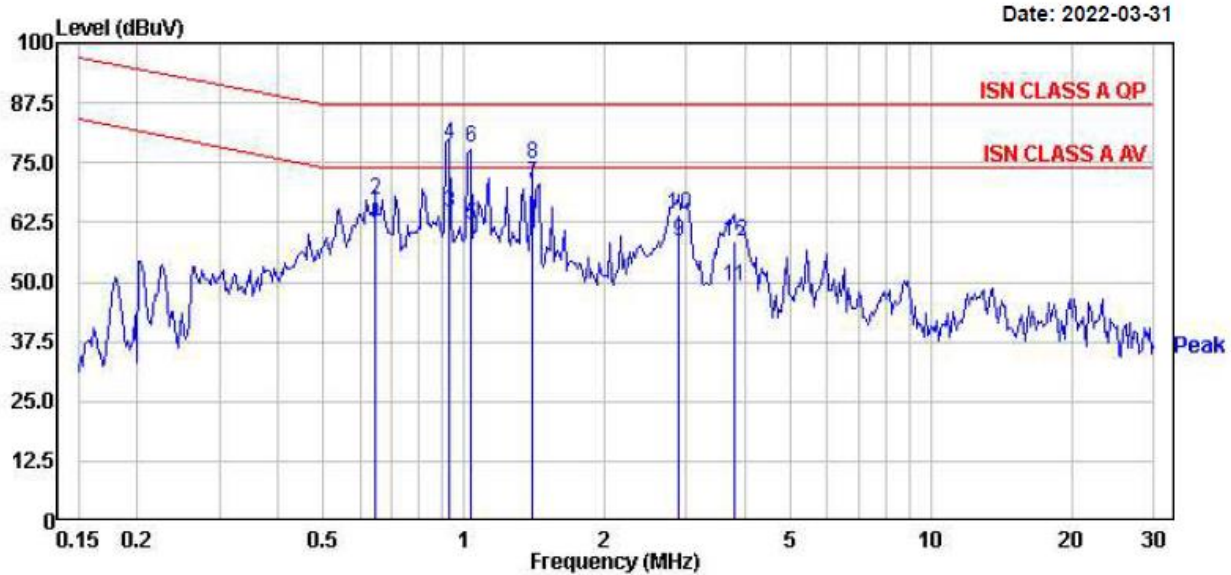

	Read Freq	Read Level	Read Factor	Limit Level	Limit Line	Over Limit	Remark
	MHz	dBuV	dB	dBuV	dBuV	dB	
1	0.647	51.13	9.62	60.75	74.00	-13.25	Average
2	0.647	57.72	9.62	67.34	87.00	-19.66	QP
3	0.928	54.82	9.55	64.37	74.00	-9.63	Average
4	0.928	69.34	9.55	78.89	87.00	-8.11	QP
5	1.032	52.43	9.54	61.97	74.00	-12.03	Average
6	1.032	68.72	9.54	78.26	87.00	-8.74	QP
7	1.403	61.22	9.52	70.74	74.00	-3.26	Average
8	1.403	65.30	9.52	74.82	87.00	-12.18	QP
9	2.884	48.99	9.47	58.46	74.00	-15.54	Average
10	2.884	54.84	9.47	64.31	87.00	-22.69	QP
11	3.799	39.72	9.47	49.19	74.00	-24.81	Average
12	3.799	48.84	9.47	58.31	87.00	-28.69	QP



**Test Data – Radiated Emission-Below 1GHz**

Polarization: Horizontal

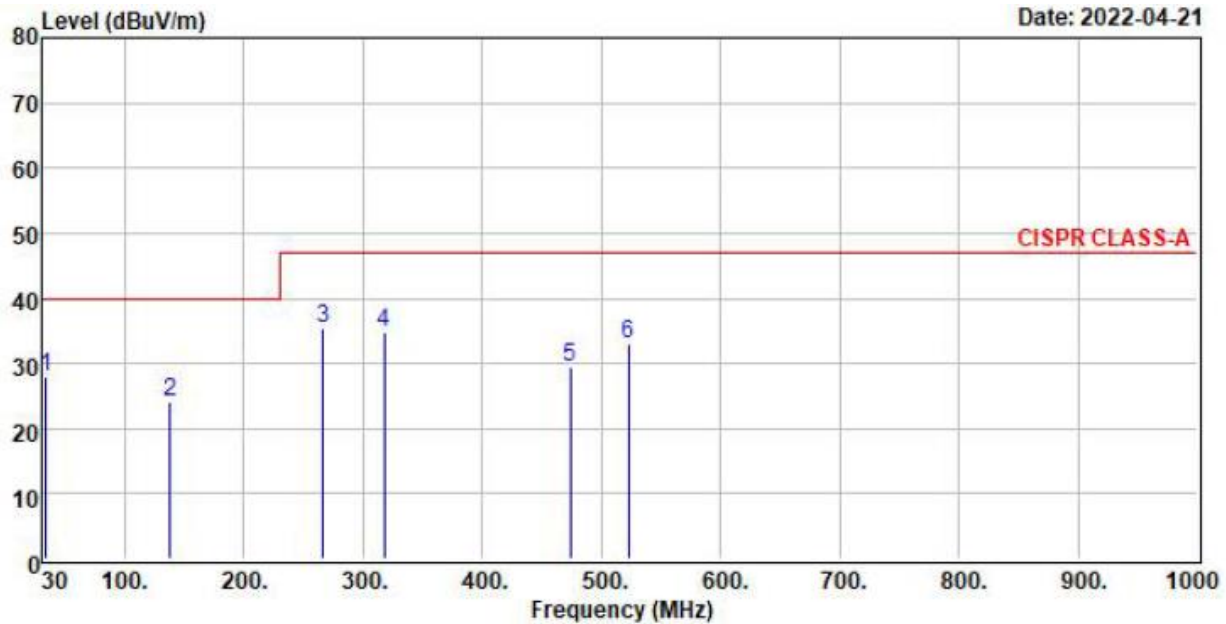

Remarks : 1.Result=Read Value+Factor  
: 2.Factor=Antenna Factor+Cable loss-  
: Amplifier Factor

	Freq	Level	Read	Over	Limit	
	MHz	dBuV/m	Level	Factor	Limit	Line Remark
			dBuV	dB/m	dB	dBuV/m
1	33.26	27.85	44.10	-16.25	-12.15	40.00 QP
2	138.22	23.96	38.00	-14.04	-16.04	40.00 QP
3 @	266.56	35.29	49.81	-14.52	-11.71	47.00 QP
4	317.28	34.85	48.19	-13.34	-12.15	47.00 QP
5	474.12	29.59	39.42	-9.83	-17.41	47.00 QP
6	522.66	32.96	41.94	-8.98	-14.04	47.00 QP





Polarization: Vertical

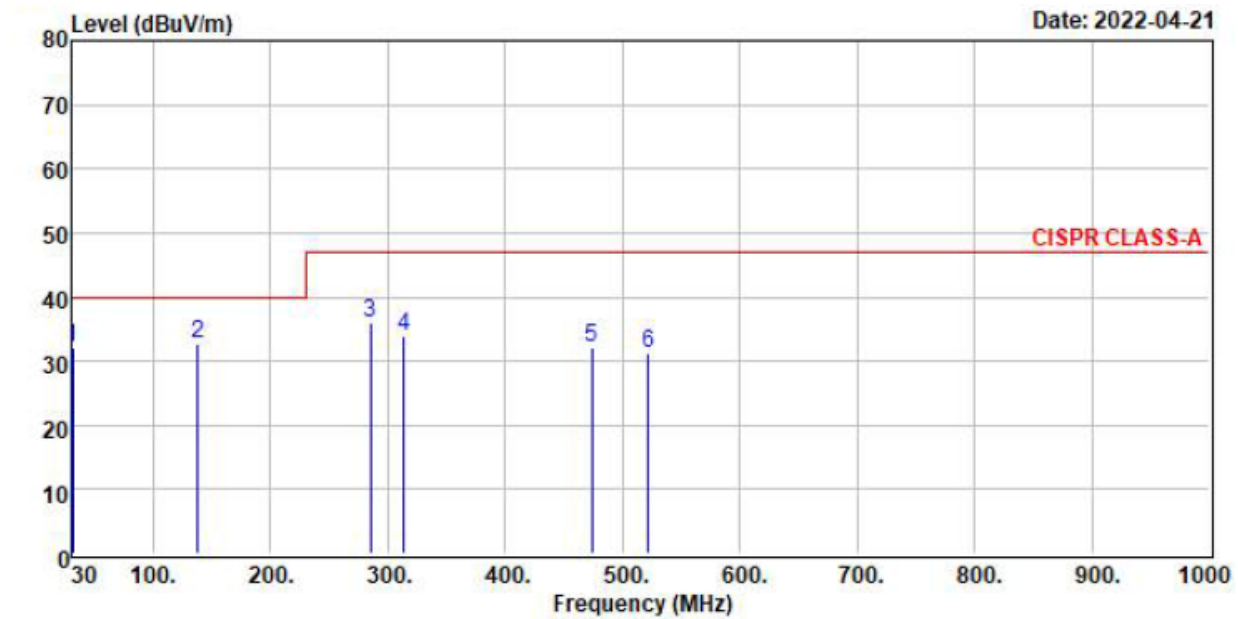

Remarks : 1.Result=Read Value+Factor  
: 2.Factor=Antenna Factor+Cable loss-  
: Amplifier Factor

	Freq	Level	Read	Over	Limit		
	MHz	dBuV/m	Level	Factor	Limit	Line	Remark
			dBuV	dB/m	dB	dBuV/m	
1	31.59	32.26	47.75	-15.49	-7.74	40.00	QP
2 @	138.22	32.62	46.66	-14.04	-7.38	40.00	QP
3	284.85	36.00	49.99	-13.99	-11.00	47.00	QP
4	313.77	33.96	47.36	-13.40	-13.04	47.00	QP
5	474.18	32.26	42.09	-9.83	-14.74	47.00	QP
6	522.18	31.26	40.26	-9.00	-15.74	47.00	QP



**Test Data – Radiated Emission-Above 1GHz**

Polarization: Horizontal

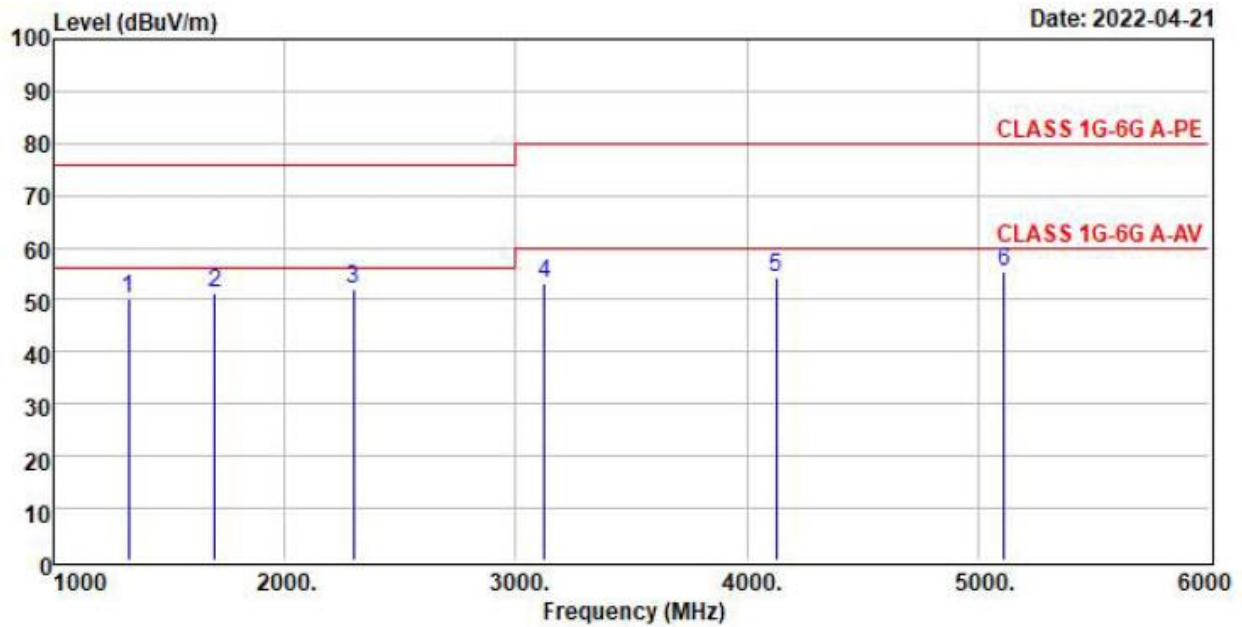

Remarks : 1.Result=Read Value+Factor  
: 2.Factor=Antenna Factor+Cable loss-  
: Amplifier Factor

		Read	Over	Limit			
Freq	Level	Level	Factor	Limit	Line	Remark	
MHz	dBuV/m	dBuV	dB/m	dB	dBuV/m		
1	1326.00	50.32	65.75	-15.43	-25.68	76.00	Peak
2	1699.00	51.32	64.78	-13.46	-24.68	76.00	Peak
3 @	2299.00	52.16	62.37	-10.21	-23.84	76.00	Peak
4	3126.00	53.26	60.33	-7.07	-26.74	80.00	Peak
5	4126.00	54.25	59.87	-5.62	-25.75	80.00	Peak
6	5111.00	55.32	59.04	-3.72	-24.68	80.00	Peak



Polarization: Vertical

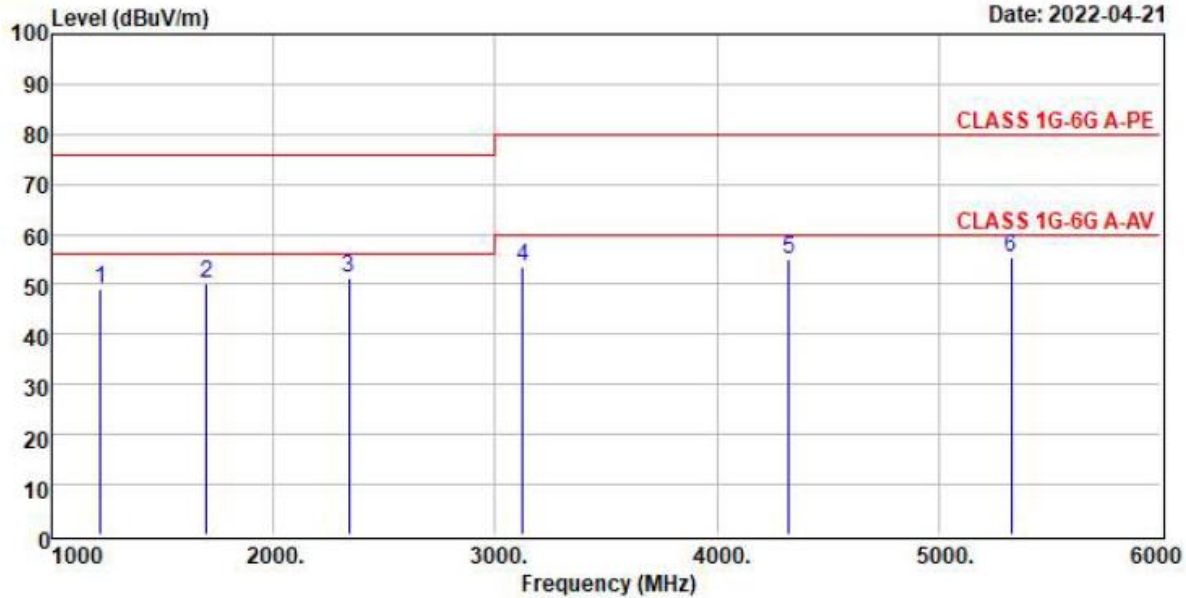

Remarks : 1.Result=Read Value+Factor  
: 2.Factor=Antenna Factor+Cable loss-  
: Amplifier Factor

	Freq	Level	Read Level	Factor	Over Limit	Limit	Line	Remark
	MHz	dBuV/m	dBuV	dB/m	dB	dBuV/m		
1	1222.00	49.18	65.00	-15.82	-26.82	76.00		Peak
2	1697.00	50.32	63.83	-13.51	-25.68	76.00		Peak
3	2340.00	51.28	61.40	-10.12	-24.72	76.00		Peak
4	3126.00	53.62	60.69	-7.07	-26.38	80.00		Peak
5	4326.00	54.85	59.90	-5.05	-25.15	80.00		Peak
6 @	5326.00	55.32	58.58	-3.26	-24.68	80.00		Peak



**Test Data – Power Harmonic**  
**Harmonics – Class-D per IEC 61000-3-2:2018/AMD1:2020(Run time)**

EUT: 22032901  
Test category: Class-D (European limits)  
Test date: 2022/4/7  
Test duration (min): 5  
Comment: Comments  
Customer: Customer

Tested by: Rex  
Test Margin: 100  
Start time: AM 11:34:48  
End time: AM 11:39:59  
Data file name: H-000128.cts\_data

Test Result: N/L      Source qualification: Normal

Current & voltage waveforms

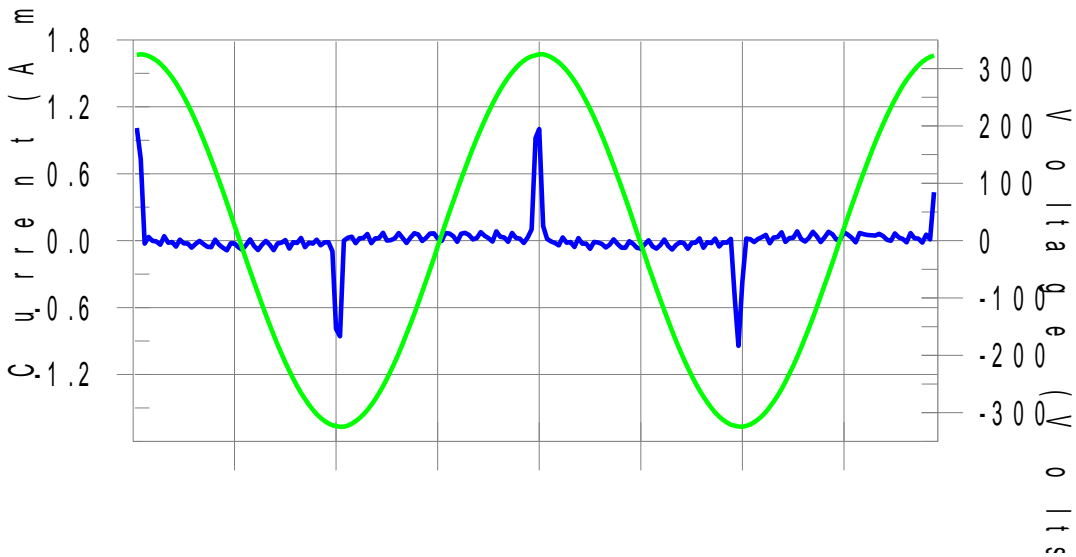

Harmonics and Class D limit line      European Limits

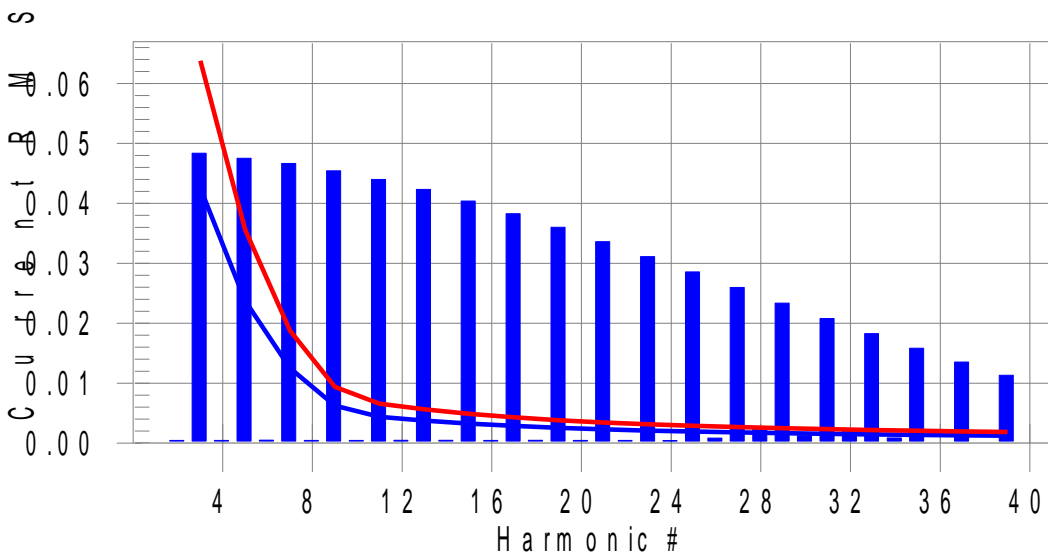

**Test result: N/L      Worst harmonics H0-0.0% of 150% limit, H0-0% of 100% limit**



## Current Test Result Summary (Run time)

EUT: 22032901  
 Test category: Class-D (European limits)      Tested by: Rex  
 Test date: 2022/4/7      Start time: AM 11:34:48      Test Margin: 100  
 Test duration (min): 5      End time: AM 11:39:59  
 Comment: Comments      Data file name: H-000128.cts\_data  
 Customer: Customer

Test Result: N/L      Source qualification: Normal  
 THC(A): 0.150      I-THD(%): 237.9      POHC(A): 0.074      POHC Limit(A): 0.005

### Highest parameter values during test:

V\_RMS (Volts): 229.69      Frequency(Hz): 50.00  
 I\_Peak (Amps): 1.206      I\_RMS (Amps): 0.188  
 I\_Fund (Amps): 0.063      Crest Factor: 7.639  
 Power (Watts): 12.5      Power Factor: 0.303

Harm#	Harms(avg)	100%Limit	%of Limit	Harms(max)	150%Limit	%of Limit	Status
2	0.000	0.000	N/A	0.001	0.000	N/A	N/L
3	0.048	0.043	N/A	0.054	0.064	N/A	N/L
4	0.000	0.000	N/A	0.001	0.000	N/A	N/L
5	0.048	0.024	N/A	0.054	0.036	N/A	N/L
6	0.000	0.000	N/A	0.001	0.000	N/A	N/L
7	0.047	0.013	N/A	0.052	0.019	N/A	N/L
8	0.000	0.000	N/A	0.001	0.000	N/A	N/L
9	0.045	0.006	N/A	0.051	0.009	N/A	N/L
10	0.000	0.000	N/A	0.001	0.000	N/A	N/L
11	0.044	0.004	N/A	0.049	0.007	N/A	N/L
12	0.000	0.000	N/A	0.001	0.000	N/A	N/L
13	0.042	0.004	N/A	0.047	0.006	N/A	N/L
14	0.000	0.000	N/A	0.001	0.000	N/A	N/L
15	0.040	0.003	N/A	0.045	0.005	N/A	N/L
16	0.000	0.000	N/A	0.001	0.000	N/A	N/L
17	0.038	0.003	N/A	0.043	0.004	N/A	N/L
18	0.000	0.000	N/A	0.001	0.000	N/A	N/L
19	0.036	0.003	N/A	0.040	0.004	N/A	N/L
20	0.000	0.000	N/A	0.001	0.000	N/A	N/L
21	0.034	0.002	N/A	0.037	0.003	N/A	N/L
22	0.000	0.000	N/A	0.001	0.000	N/A	N/L
23	0.031	0.002	N/A	0.034	0.003	N/A	N/L
24	0.000	0.000	N/A	0.001	0.000	N/A	N/L
25	0.029	0.002	N/A	0.031	0.003	N/A	N/L
26	0.001	0.000	N/A	0.001	0.000	N/A	N/L
27	0.026	0.002	N/A	0.028	0.003	N/A	N/L
28	0.002	0.000	N/A	0.003	0.000	N/A	N/L
29	0.023	0.002	N/A	0.026	0.002	N/A	N/L
30	0.001	0.000	N/A	0.002	0.000	N/A	N/L
31	0.021	0.002	N/A	0.023	0.002	N/A	N/L
32	0.002	0.000	N/A	0.003	0.000	N/A	N/L
33	0.018	0.001	N/A	0.020	0.002	N/A	N/L
34	0.001	0.000	N/A	0.001	0.000	N/A	N/L
35	0.016	0.001	N/A	0.017	0.002	N/A	N/L
36	0.000	0.000	N/A	0.000	0.000	N/A	N/L
37	0.014	0.001	N/A	0.014	0.002	N/A	N/L
38	0.000	0.000	N/A	0.000	0.000	N/A	N/L
39	0.011	0.001	N/A	0.012	0.002	N/A	N/L
40	0.000	0.000	N/A	0.000	0.000	N/A	N/L

Note: The EUT power level is below 75.0 Watts and therefore has no defined limits



## Voltage Source Verification Data (Run time)

EUT: 22032901  
 Test category: Class-D (European limits)  
 Test date: 2022/4/7  
 Test duration (min): 5  
 Comment: Comments  
 Customer: Customer

Tested by: Rex  
 Test Margin: 100  
 Start time: AM 11:34:48  
 End time: AM 11:39:59  
 Data file name: H-000128.cts\_data

Test Result: N/L      Source qualification: Normal

### Highest parameter values during test:

Voltage (Vrms):	229.69	Frequency(Hz):	50.00
I_Peak (Amps):	1.206	I_RMS (Amps):	0.188
I_Fund (Amps):	0.063	Crest Factor:	7.639
Power (Watts):	12.5	Power Factor:	0.303

Harm#	Harmonics V-rms	Limit V-rms	% of Limit	Status
2	0.010	0.459	2.25	OK
3	0.464	2.067	22.44	OK
4	0.025	0.459	5.51	OK
5	0.028	0.919	3.02	OK
6	0.014	0.459	2.99	OK
7	0.037	0.689	5.33	OK
8	0.005	0.459	1.00	OK
9	0.031	0.459	6.80	OK
10	0.003	0.459	0.59	OK
11	0.029	0.230	12.82	OK
12	0.009	0.230	3.75	OK
13	0.029	0.230	12.70	OK
14	0.002	0.230	1.02	OK
15	0.030	0.230	13.19	OK
16	0.007	0.230	3.06	OK
17	0.027	0.230	11.79	OK
18	0.009	0.230	3.93	OK
19	0.033	0.230	14.22	OK
20	0.010	0.230	4.29	OK
21	0.032	0.230	14.03	OK
22	0.003	0.230	1.25	OK
23	0.033	0.230	14.41	OK
24	0.002	0.230	0.73	OK
25	0.033	0.230	14.54	OK
26	0.002	0.230	0.73	OK
27	0.033	0.230	14.38	OK
28	0.001	0.230	0.60	OK
29	0.029	0.230	12.75	OK
30	0.003	0.230	1.21	OK
31	0.027	0.230	11.61	OK
32	0.002	0.230	0.65	OK
33	0.025	0.230	10.99	OK
34	0.001	0.230	0.62	OK
35	0.023	0.230	10.02	OK
36	0.001	0.230	0.63	OK
37	0.020	0.230	8.82	OK
38	0.001	0.230	0.55	OK
39	0.019	0.230	8.06	OK
40	0.007	0.230	2.88	OK



Test Data – Voltage Fluctuations

Flicker Test Summary per IEC61000-3-3:2013/AMD1:2017 (Run time)

EUT: 22032901  
Test category: All parameters (European limits)  
Test date: 2022/4/7  
Test duration (min): 10  
Comment: Comments  
Customer: Customer  
Tested by: Rex  
Test Margin: 100  
Start time: AM 11:45:29  
End time: AM 11:55:56  
Data file name: F-000129.cts\_data

Test Result: Pass Status: Test Completed

Pst<sub>i</sub> and limit line

European Limits

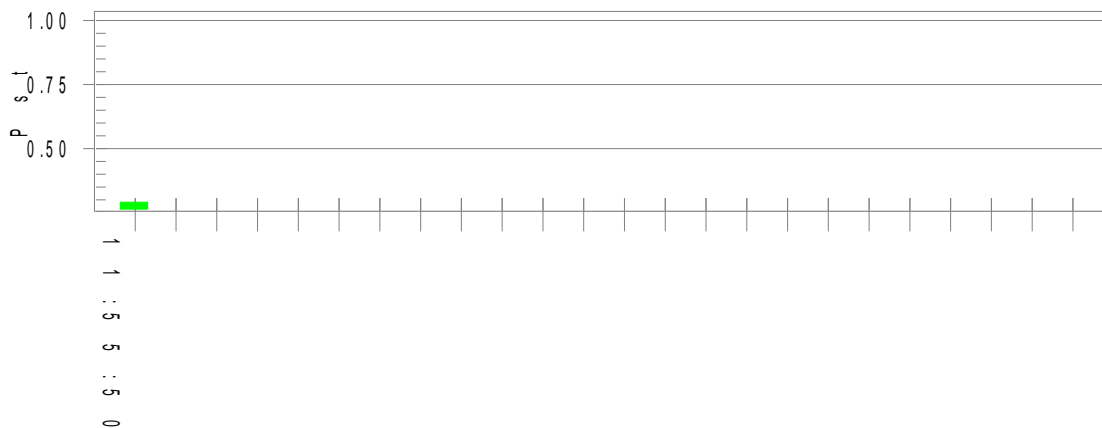

Plt and limit line

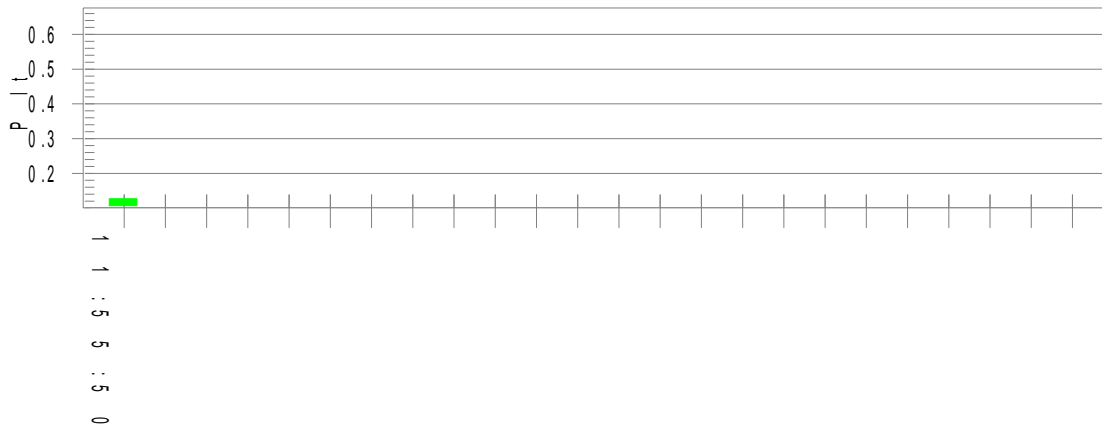

Parameter values recorded during the test:

Vrms at the end of test (Volt):	226.59		
Highest dt (%):		Test limit (%):	
T-max (mS):	0	Test limit (mS):	500.0 Pass
Highest dc (%):	0.00	Test limit (%):	3.30 Pass
Highest dmax (%):	0.00	Test limit (%):	4.00 Pass
Highest Pst (10 min. period):	0.291	Test limit:	1.000 Pass
Highest Plt (2 hr. period):	0.127	Test limit:	0.650 Pass



# PHOTOS OF EUT





